

**Project X as a Proton Driver  
for a  
Neutrino Factory and/or a Muon Collider**

by

**Muons, Inc. and Fermilab Staff**

**January 26, 2010**

**Abstract**

Project X is the current name for Fermilab's plans for a major augmentation of its proton-based accelerators. The proposed statement of mission need for Project X includes the requirement that there be an upgrade path to provide the proton beams needed by neutrino factories and/or muon colliders. This document discusses the ramifications of that requirement. While originally envisioned to be two reports, one for each application, the present single document allows a description of those aspects of a proton driver which are common to both a neutrino factory and a muon collider and, more importantly, allows coherent descriptions of development paths that are relevant for both applications.

## Table of Contents

Table of Contents .....	2
Executive Summary .....	3
1 Introduction .....	5
2 Proton Beam Requirements .....	8
2.1 Accelerator Requirements for Near-Term Experiments .....	8
2.2 Neutrino Factory Requirements .....	8
2.2.1 Energy and Power Requirements .....	9
2.2.2 Beam Structure Requirements .....	11
2.3 Muon Collider Requirements .....	12
2.3.1 Muon Collider Conceptual Layout .....	12
2.3.2 Parameters and Design Concepts .....	12
2.3.3 Power and Beam Structure Requirements for the Proton Source .....	17
3 Facility Concepts .....	19
3.1 IC-1 Linac .....	19
3.1.1 General Configuration .....	19
3.1.2 IC-1 Operation .....	22
3.1.3 IC-1 upgrade path(s) .....	22
3.2 IC-2 Linac .....	23
3.2.1 IC-2 Operation .....	25
4 Additional Facilities Needed for Either Facility Concept .....	26
4.1 Accumulator Ring .....	28
4.1.1 Space-charge Tune Shifts .....	30
4.1.2 e-p Instability .....	30
4.1.3 Many Injection Turns .....	31
4.2 Bunch Rotation Ring .....	32
4.3 External Combiner .....	36
4.3.1 Trombone .....	37
4.3.2 Funnel .....	37
5 Proton Driver Development Plan Based on IC-2.2 Linac .....	38
5.1 The first-stage proton driver .....	38
5.2 The second-stage proton driver .....	43
5.3 The third-stage proton driver .....	45
6 Conclusions and Recommendations .....	45
Bibliography and References .....	48
Appendix 1: Ion Sources .....	51
Negative Ion Sources for Project X .....	51
Ion Source with Flexible Ion Beam Chopping .....	55
Appendix 2: CW SRF linac for MC, NF, rare decays, AHIPA 09 .....	62
Appendix 3: P-X, SRF, and Very Large Power Stations, AHIPA 09 .....	66

## Executive Summary

This report discusses how to augment Fermilab's Project X to provide the proton beams required to drive neutrino factories and muon colliders. Various design concepts for Project X have been considered, all based upon a multi-GeV superconducting H<sup>-</sup> linac with considerable beam power. One initial configuration (IC-1) is based upon an 8 GeV pulsed linac; a second concept (IC-2) includes a CW linac of about 3 GeV.

The designs of muon colliders and neutrino factories are also evolving, but all concepts require about 4 MW of proton beam power delivered to a pion production target in short (few ns rms) bunches at rates of tens of bunches per second (for a muon collider at the energy frontier) to hundreds (for a neutrino factory or a muon collider Higgs or Z' factory). The International Scoping Study for a Neutrino Factory specifies that the proton kinetic energy should be in the range from 5 to 15 GeV, and it is believed that the optimum proton energy for a muon collider is likely to fall in the same range.

The required time distribution of proton bunches implies "post-processing" downstream of the linac, and the most feasible post-processor consists of a pair of rings, one to accumulate the desired number of bunches and a second to shorten the bunches. Since fixed-energy storage rings have many advantages over synchrotrons for these applications, the linac must deliver the full energy that is required by the storage rings. If necessary, the second ring would be followed by an external bunch combiner to cause a few bunches at a time to arrive simultaneously at the pion production target.

Both initial configuration linacs would have to be upgraded to serve these purposes. The 8-GeV pulsed linac of IC-1 would need a beam power upgrade to ~ 4 MW by increasing the beam current, the pulse duration, and/or the repetition rate. The CW linac of IC-2 would have to be extended to a higher energy, with a beam current corresponding to ~ 4 MW or more. Ideally, these upgrades should occur as soon as possible after completion of the initial project, and the initial design must provide the necessary upgrade potential. For example, it would be straightforward to extend the IC-2 linac using the same CW technology that is used in the downstream end of the original linac.

A study of cost optimizations should include RF cavity improvements for higher Q, higher-efficiency lower-cost power sources, refrigeration, and, if Project-X is to replace the Booster, any modifications to the Main Injector that might be needed to allow lower injection energy.

The requirements on the proton driver for these purposes are quite daunting, well beyond the currently demonstrated state of the art. Accordingly, the design must incorporate the best features of existing state-of-the-art designs. Ideally, it must also provide considerable flexibility to adapt to differing programmatic requirements and unanticipated operational limitations. In response to these challenges, we have developed several new concepts to enhance the feasibility and to reduce the cost of a proton driver. One new concept is the aforementioned external bunch combiner. Other new concepts promise to extend the art

of foil stripping technology in order to facilitate charge-exchange injection of very many turns from a CW linac into a storage ring. Three of these new concepts, resonant foil bypass, longitudinal foil segmentation, and foil rotation, are described in the report.

Finally, a particular three-stage development plan for a proton driver is described, starting with a 3 GeV,  $\sim 0.5$  mA CW SRF H<sup>-</sup> linac and ending with the proton bunch parameters required at the pion production target for a muon collider. The *first stage* uses a 3-GeV storage ring to accumulate 3 bunches of protons at a time from the linac, operating on a 70 Hz cycle. The bunches would then be shortened, in the same ring or a second one, for delivery to a pion production target to make muons for a neutrino factory based on a muon storage ring. The *second stage* uses the protons from a CW linac extension to 6 GeV with a current of 0.667 mA to provide 4 MW of beam power. The same ring(s) as in the first stage, operating at a correspondingly higher magnetic field, would be used to accumulate and shorten three bunches, still at 70 Hz, for a more powerful neutrino factory. An energy of 6 GeV is also high enough to inject directly into the Main Injector. The *third stage* uses the same systems, augmented by an external bunch combiner (a trombone plus a funnel), to drive a muon collider at a 15-Hz rate.

The specific input numerical values used in this three-stage plan fall within the range of values specified by the proponents of neutrino factories and muon colliders and are chosen to maximize the plausibility that each stage is feasible; in particular, space-charge tune shifts in the rotator ring are tolerable in each case. Somewhat different choices of parameter values at each stage may result from detailed optimizations supported by simulations and other R&D.

## 1 Introduction

Fermilab is formulating plans for Project X, its working title for a proposed major augmentation of its proton accelerator complex. One of the goals of Project X, broadly stated, is to provide beams for physics at the intensity frontier. Project X must also be upgradeable in order to provide the future capability of driving a neutrino factory and/or a muon collider. The primary purpose of this document is to discuss how to augment whatever facilities are built to provide that future capability.

Traditionally it is usually considered that high energy machines and high intensity machines provide complementary physics programs. It is often considered that high energy machines provide the potential for new physics, while high intensity machines facilitate precision measurements. However, as the luminosity demands of high energy colliders have increased, the current accelerators, such as the Tevatron and LHC, have had to move toward using higher intensity injectors to meet the luminosity demands. The goals of Project X continue this blurring of how the intensity and energy frontier are considered. The intense proton beam provided by Project X can do more than just help build a physics program at the intensity frontier; it can serve as the source of high intensity secondary beams of pions. The resulting pion beams can be used to create intense beams of muons and neutrinos. These latter beams can serve as the basis of an energy frontier program in the form of a muon collider as well as additional capabilities at the intensity frontier in the form of a neutrino factory based on a muon storage ring.

There are two kinds of facilities that this document must discuss: neutrino factories and muon colliders. Furthermore, there are several variants of accelerator facilities that have been considered in varying degrees of detail as possible realizations of Project X. Three variants, known as IC-1<sup>1</sup>, IC-2<sup>2</sup>, and IC-2.2 have received the most attention. This document might then seem to require a matrix of sections, one for each of several accelerator variants and for each of two intended purposes. Fortunately, there are similarities between the needs of neutrino factories and of muon colliders; also, there are considerable similarities among the accelerator concepts that have been proposed. Those similarities make it much more efficient to write a single coherent narrative that simultaneously addresses how the various accelerator concepts can be upgraded for both intended applications.

A physics program for Project X has been described in the “Golden Book”<sup>3</sup>, however it is reasonable to expect that the program will continue to evolve with time. The broad range of “near term” physics research that was described includes a long baseline neutrino experiment (LBNE) between Fermilab and DUSEL, flavor physics, and rare muon decay experiments. Three initial design studies have been performed to determine the accelerator configuration needed to service the near term physics program. As one looks beyond the near term time scale, a neutrino factory and a muon collider loom on the horizon. This report focuses on the possibilities of augmenting the initial design configurations in order to drive a neutrino factory and/or a muon collider. The physics

program of the neutrino factory has been described elsewhere <sup>4</sup> and consists of an extension of the initial Project X neutrino program to provide very intense beams of electron and muon neutrinos from a muon storage ring. The physics program of the Muon Collider, described elsewhere <sup>5</sup>, is based on precision studies of new states that may be discovered at the LHC and possible discovery of new high energy phenomena at the energy frontier. Both neutrino factories and muon colliders require high intensity proton beams to produce pions that result in the needed neutrinos and muons, respectively.

A neutrino factory offers an exciting longer-term extension to the current neutrino program. The physics motivation for a neutrino factory depends on the results from the current and near-term neutrino oscillation experiments. If the unknown mixing angle,  $\theta_{13}$ , is small, implying  $\sin^2 \theta_{13} < 10^{-2}$ , then further understanding of neutrino oscillations will require a neutrino factory. If on the other hand  $\sin^2 \theta_{13}$  is larger (just below current limits), then the motivation for building a neutrino factory depends on the oscillation parameters, the achievable sensitivities of the near term  $\nu_e$  appearance experiments, and the next generation questions coming from the results of the near term experiments.

Generically a neutrino factory consists of a high intensity muon source, an acceleration system, and a muon storage ring with long straight sections. A more detailed discussion of the required facilities is given in section 2.2. Muons decay along the straight sections of the storage ring and create high intensity neutrino beams. Such beams have well known flux, energy spread, and neutrino flavour content. The neutrino flavour composition of the beam depends on the charge of the muons. For example, if positively charged muons are stored in the ring, the muons decaying in the straight sections will produce a beam containing 50% muon antineutrinos and 50% electron neutrinos. The composition arises from:

$$\mu^- \rightarrow e^- + \bar{\nu}_e + \nu_\mu, \quad \mu^+ \rightarrow e^+ + \nu_e + \bar{\nu}_\mu$$

Charged current interactions of the muon-antineutrino in a far detector will produce right sign muons ( $\mu^+$ ), i.e. muons of the same sign as those present in the storage ring. Oscillations of the electron-neutrinos to muon-neutrinos will give rise to wrong sign muons ( $\mu^-$ ) in a far detector<sup>6,7</sup>. The presence of wrong sign muons in a far detector provides a clear signal of oscillations. The  $\nu_e \rightarrow \bar{\nu}_\mu$  channel has been called the golden channel<sup>8</sup>.

In order to exploit the physics potential of the golden channel, a far detector with excellent charge identification will be needed. The potential of a low energy neutrino factory, with muon energy of 4.12 GeV, has been studied<sup>9</sup>. In such a scenario the most important aspect is progress toward a far detector that can reliably measure the sign of muons for momenta in the range of a few hundred MeV/c. A development plan for using Project X to drive a low energy neutrino factory is discussed in more detail at the end of this report.

The motivation for a muon collider stems from the limitations of other collider types. Hadron collider energies are limited by their size and the constraints on the magnetic bending fields. Lepton colliders have an advantage compared to hadron colliders because leptons are pointlike particles, making the full beam energies available for fundamental processes. Extending  $e^+e^-$  colliders to the multi-TeV scale is problematic because synchrotron radiation makes it impractical to accelerate them in circular machines. Since  $m_\mu/m_e = 207$ , muons have negligible synchrotron radiation and can thus be accelerated, stored and collided in rings. Furthermore, it is possible that muon colliders may achieve luminosities comparable to those of  $e^+e^-$  colliders at the same energy. Additional advantages of muon colliders include their physical size: they are much smaller than a linear  $e^+e^-$  collider of the same energy. Additionally, they require much less precision than electron linear colliders, as the final geometric emittances are  $\sim 5$  orders of magnitude larger than an equivalent  $e^+e^-$  machine, and antiparticles circulating in opposite directions in the same magnetic ring have the same closed orbit. This makes a high energy muon collider a very attractive prospect for an energy frontier program. A muon collider would provide a facility to follow up on the discoveries at the LHC as well as being a discovery machine in its own right.

Ensuring that the accelerator configuration for Project X is able to service the broad near-term physics program and is also compatible with longer term endeavors is crucial for Fermilab. The facility should be able to deliver intense, multi-GeV proton beams for various experiments that require various bunch structures at high duty cycle. Additionally, the accelerator implementation must either be immediately compatible with the needs of the longer term programs or have a clear upgrade path. This requires flexibility in the design to account for possible changes to the initial beam specifications to meet the needs of longer term projects. Current studies on neutrino factories and muon colliders indicate the required beam power for both types of facilities is about 4 MW at an energy above about 5 GeV (with considerable performance contingency desirable- up to a factor of 2, especially for a muon collider). Eventually a decision must be made whether to design *a priori* for the required beam current or to incorporate the potential for a future intensity upgrade in the design. Regarding proton bunch structures, the neutrino factory and muon collider parameter sets call for different numbers of bunches per second delivered to the pion production target. Furthermore, it is not obvious yet what are the optimal rates of bunch delivery to the target for both facilities. Accordingly, another important design goal is to develop a bunching strategy that allows considerable flexibility.

## 2 Proton Beam Requirements

### 2.1 Accelerator Requirements for Near-Term Experiments<sup>10</sup>

Future rare-process and precision experiments require kaon and muon beams of extraordinary quality. These experiments operate at the intensity frontier, where conventional decay and interaction processes can conspire in a high-rate environment to mimic the signatures of the sought-after signals. The principal handle to control these backgrounds is the combination of detectors that deliver excellent time resolution with high duty-factor beams that minimize the instantaneous rates that the detectors must face. The joint potential of high duty factor and high availability would make the Fermilab complex a unique resource for rare-process and precision experiments.

Both the muon and kaon programs could have Phase Zero operation (using beam from the Booster) before the high-power Project X era in its initial configuration (Phase I). A conceptual scheme has been developed to establish the required bunch structures for Phase Zero operation of the Mu2e and muon (g-2) experiments with an evolution of the existing Accumulator and Debuncher complex. These schemes are described in some detail in the Mu2e and g-2 experiment proposals. The proton beam bunch train requirements for the kaon and muon programs are listed below in Table 1.

	Train Frequency	Pulse Width (nanoseconds)	Inter-Pulse Extinction
Kaon experiments	20-30 MHz	<0.2	$10^{-3}$
Muon conversion experiment	0.5-1.0 MHz	<100	$10^{-9*}$
$\mu \rightarrow e\gamma$ & $\mu \rightarrow eee$ experiments	80-300 MHz	<0.2	---
Muon g-2 experiment	30-100 Hz	50	---

**Table 1: Bunch train requirements for the kaon and muon rare process and precision programs.**

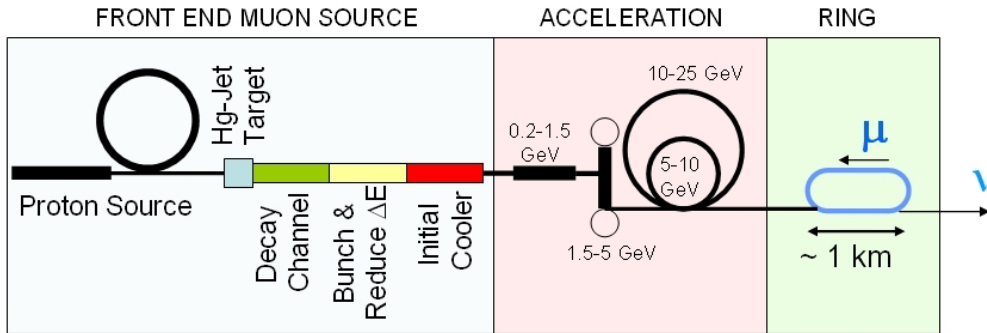
*\*Extinction for the muon conversion experiment is achieved by a combination of extinction in the circulating beam/extraction systems and in an external device in the proton beam transport.*

### 2.2 Neutrino Factory Requirements

A schematic representation of a neutrino factory is shown in Figure 1. The neutrino factory front end includes a proton source, a high-power target, a decay channel, facilities to bunch the beam and reduce its energy spread, and an initial cooling stage. The primary proton beam hits the target to create a pion beam, which decays into a muon beam in the decay channel. The muon beam is manipulated to give the desired bunch structure and to reduce the energy spread and the transverse emittances for delivery to the acceleration systems. The acceleration stages raise the muon beam energy from about 0.2 GeV to a final energy of about 4 GeV (in an initial low-energy version<sup>11</sup>) or about 25 GeV in an upgraded version<sup>12</sup>. The high energy muons are sent to a storage ring with long straight



sections in which the muons decay to produce intense neutrino beams. The primary concerns of this report are the details of the power and formatting of the beam provided by the Proton Source and how the candidate designs meet the needs of the neutrino factory and the muon collider.



**Figure 1: Schematic layout of a neutrino factory. Design details such as the use of accumulator/debuncher and acceleration schemes such as recirculating linear accelerators are discussed in later sections.**

### 2.2.1 Energy and Power Requirements

The average proton beam power needed for a neutrino factory is 4 MW, based on the requirement of neutrino fluxes of  $10^{21}$  muon decays per year for each sign<sup>13</sup>. The International Scoping Study (ISS)<sup>14</sup> called for proton kinetic energy in the range from 5 to 15 GeV. It has been demonstrated that liquid mercury targets can operate at and above 4 MW of beam power<sup>15</sup>. There have been a number of simulation studies of pion production as a function of proton energy, and recently data from the HARP experiment has become available.

Earlier pion production simulations, based on MARS14, show that pion production peaks when the proton energy is  $\sim 8$  GeV and falls slowly as the proton energy increases; cf. Figure 2(a). Recent simulations of pion production as a function of proton energy using MARS15, shown in Figure 2(b), also show that pion production peaks at a proton energy of  $\sim 8$  GeV<sup>16</sup>. The new simulations show a faster falloff of pion production rates above 8 GeV than were found in the previous simulations<sup>17</sup>.

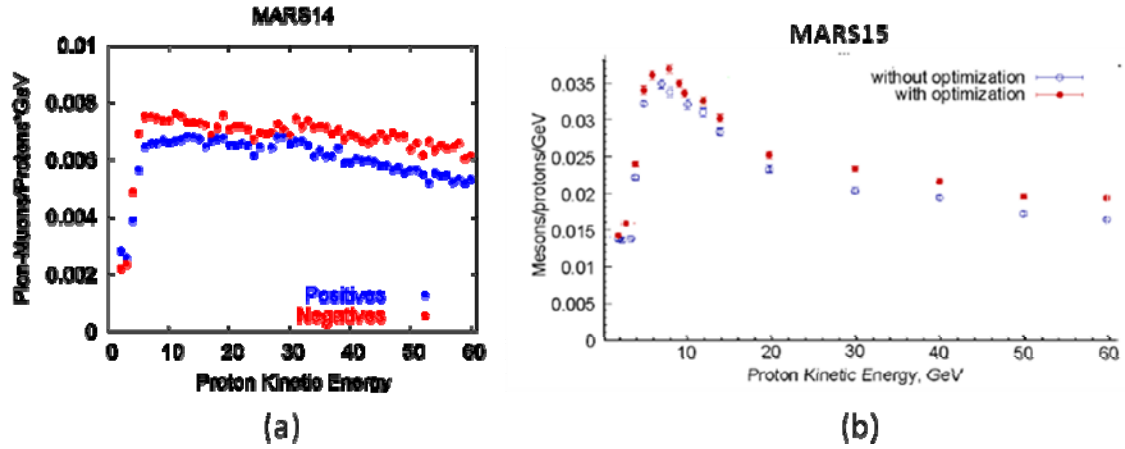


Figure 2: Pion and muon production rates as a function of incident proton energy; (a) based on MARS14 simulations, (b) based on MARS15 simulations.

Measurements from the HARP experiment have recently become available<sup>18</sup>. The results, shown in Figure 3(a), fall off more gradually below 8 GeV than either the MARS14 or the MARS15 simulations. Some adjustments to the MARS15 production model<sup>19</sup> were made to align the simulations with the data, as shown in Figure 3(b). The simulation was adjusted to coincide with the data at 4.2 GeV, and the results agree with the data in the range 2 GeV to 12 GeV. These results indicate that the optimal beam energy for production of useful pions occurs at lower energies, 4 to 6 GeV or even lower, than the 8 GeV previously considered optimal. This implies that a linac energy considerably less than 8 GeV may be optimal for a future NF/MC proton source. However, the proton beam is more stable, particularly against space-charge effects, at higher energy.

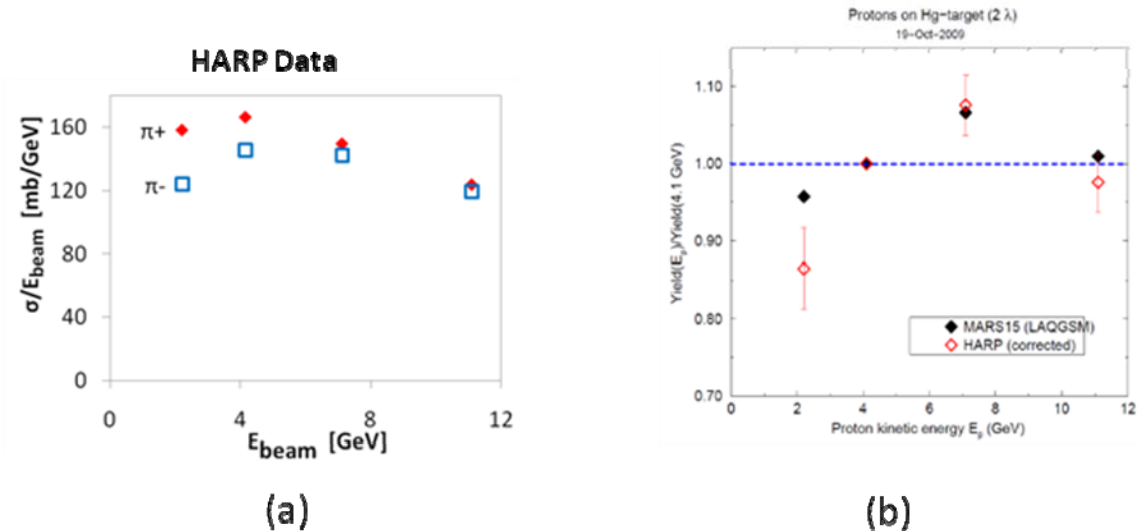


Figure 3: Pion production vs. proton beam energy; (a) data from HARP measurements, (b) comparison of HARP data and MARS15 simulation results, normalized to be the same at 4.2 GeV.

### 2.2.2 Beam Structure Requirements

Not only do the proton beam bunches need to be intense, they also need to be short because the process of capturing muons in RF buckets downstream of the target<sup>20</sup> relies on the correlation between momentum and arrival time that develops after a lengthy drift space. An rms bunch length of 1 ns is preferred, but 2 or 3 ns is considered acceptable; the captured muon flux drops by about 5% for bunch lengths of 3 ns compared to 1 ns. Providing such short and intense bunches will be challenging.

The pulse repetition rate for a neutrino factory is bounded from above and below by its implications on the target and beam. Since a major figure of merit for a neutrino factory is muon flux, the bunch delivery rate for a given beam power will not have a major impact on NF performance provided that the various subsystems can cope with the bunch intensities and the repetition rate. The maximum cycle rate is limited to about 70 Hz by target disruption (if using a Hg jet). For a neutrino factory, the ISS specified that the proton beam should be delivered in bursts of 3 closely spaced bunches at a 50 Hz cycle rate; in other words, the ISS called for 150 bunches per second. The three bunches per cycle must be spaced closely enough so that the target does not have time to disrupt, and far enough apart to satisfy other requirements downstream of the target. The minimum repetition rate (for a given beam power) may be limited by space charge effects and other instabilities in the rings; the details will be discussed later.

Again for a given proton beam power, the repetition rate may have a more important effect on the performance of a muon collider than on that of a neutrino factory because the luminosity of a collider scales with the square of the muon bunch intensity until the beam-beam tune shift limit is reached. At the beam-beam limit, the repetition rate can be raised for a given luminosity, thereby mitigating various deleterious effects dependent on the bunch intensities, provided that the transverse emittances of the muon bunches can be reduced by more effective cooling. Table 2 gives a representative set of neutrino factory parameters.

Quantity	Units	Value
Proton Kinetic energy	GeV	4-15
Average beam power	MW	4
Pulse repetition frequency	Hz	50
Proton rms bunch length	ns	2±1
Number of bunches per pulse		3
Sequential extraction delay	μs	≥17
Pulse duration, liquid-Hg target	μs	≤280

**Table 2: Neutrino factory requirements summary**

## 2.3 Muon Collider Requirements

### 2.3.1 Muon Collider Conceptual Layout

A schematic representation of a muon collider is shown in Figure 4. The muon collider front end is schematically the same as a neutrino factory. It includes a proton source, a high-power target, a decay channel, facilities to bunch the beam and reduce its energy spread, and an initial cooling stage. The primary proton beam hits the target to create a pion beam, which decays into a muon beam in the decay channel. The muon beam is manipulated to give the desired bunch structure and to reduce the energy spread to facilitate subsequent processing. Following the front end muon source is the 6D Cooling stage, which cools the beam in all six phase space dimensions. The 6D Cooling stage consists of several types of cooling devices to reduce the emittances by large factors to make acceleration easier and ultimate luminosity higher. The 6D Cooling stage requires RF acceleration to maintain the longitudinal momentum at  $\sim 0.2$  GeV/c. The acceleration stages raise the muon beam energy from about 0.2 GeV to a final energy of  $\sim 2$  TeV. The high energy muons are sent to a collider ring in which the muon beams intersect within one or more experimental detectors. Details of the cooling, acceleration and collider ring stages are beyond the scope of this document. The primary concerns of this report are the details of the power and formatting of the beam provided by the Proton Source and how the candidate designs meet the needs of both muon colliders and neutrino factories.

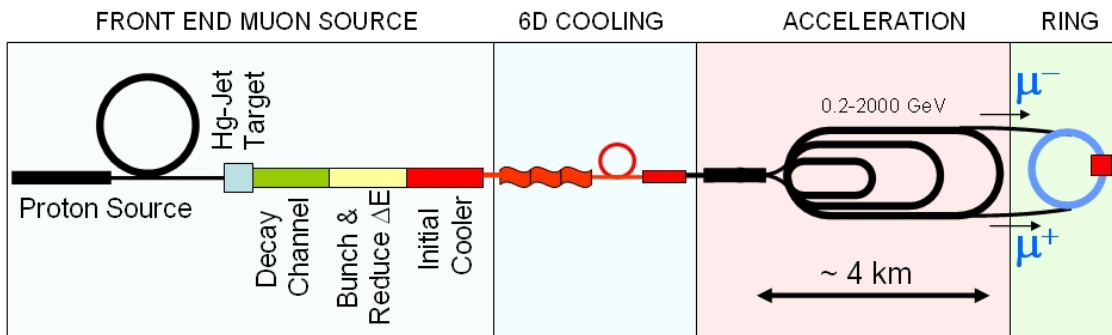


Figure 4: Schematic layout of a Muon Collider

### 2.3.2 Parameters and Design Concepts

Muon colliders with center-of mass energy  $\sqrt{s}$  in the 1 TeV to 4 TeV range have been studied in various previous design efforts<sup>21</sup>. The lower end of the range represents a significant step beyond the ILC energy of 0.5 TeV; the upper end corresponds to the maximum-sized facility that could be accommodated within the Fermilab site boundaries. Two particular energies that have been studied are 1.5 TeV and 3 TeV. Past physics studies have shown that a Muon Collider with  $\sqrt{s} = 1$  TeV to a few TeV requires a luminosity of  $\sim 10^{34} \text{ cm}^{-2} \text{ s}^{-1}$  to probe the physics beyond the Standard Model with adequate sensitivity. For the two energies, 1.5 TeV and 3 TeV, the estimated required

luminosities are  $0.8 \times 10^{34}$  and  $3 \times 10^{34}$  respectively<sup>22</sup>. How the requirements for luminosity translate into requirements for the proton source depends on many factors such as the emittances of the muon beams in the collider ring, the performance of the cooling stage, the design of the acceleration stage, losses due to decays of the muons, targeting and capture efficiency at the production target, etc.

The luminosity in Gaussian circular colliding beams of transverse emittance  $\epsilon_T$  with  $n_b$  bunches of each sign, each of intensity  $N_\mu$ , is given by:

$$\mathcal{L} \sim \frac{R_b n_b N_\mu^2}{\epsilon_T \beta^*} \mathcal{H}(\beta^*/\sigma_z) \sim \frac{R_b n_b N_\mu \xi}{\beta^*} \mathcal{H}(\beta^*/\sigma_z)$$

where  $\beta^*$  is the betatron amplitude function at the collision point,  $\sigma_z$  is the bunch length,  $R_b$  is the proton repetition rate, and  $\mathcal{H}$  is the hour-glass factor, which accounts for reduction of the luminosity due to depth-of-focus effects as the bunches meet head-on. The luminosities normally quoted are values averaged over a cycle, taking into account the muon lifetime.

$$\xi = \frac{r_\mu N_\mu}{4\pi\epsilon_T}$$

is the beam-beam parameter, and  $r_\mu$  is the classical muon radius. Once the beam-beam limit is reached (typically  $N_{IP} \xi < 0.2$  for a muon collider, where  $N_{IP}$  is the number of intersection points, probably 2 for a muon collider), lowering the transverse emittance no longer directly increases the luminosity. To benefit from further emittance reduction requires lowering the number of muons per bunch,  $N_\mu$ , and increasing the number of bunches  $n_b$  per cycle or the repetition rate of proton bunches delivered to the production target.

With these considerations in mind, three design concepts have emerged to achieve luminosities of the order of  $10^{34} \text{ cm}^{-2} \text{ s}^{-1}$  for a muon collider. Noting that the luminosity is inversely proportional to the transverse emittance, the designs have been based on (and labeled by) their respective projected emittances – high, medium, and low. The parameters for the three concepts are given in Table 3. Parameters are shown for the three concepts for a 1.5 TeV muon collider and for a 3 TeV collider in the high emittance concept. It is not our purpose to advocate a particular concept or to explain in detail the components assumed for each concept, but rather to use these concepts to give an idea of the range of parameter values that apply to a muon collider, and how they may affect the design of the proton source for Project X.

**Table 3: Parameter Lists for Three Design Concepts<sup>23</sup>**

Design Concept Parameter	Symbol	Units	Low $\epsilon$	Med $\epsilon$	High $\epsilon$	High $\epsilon$
CM Energy	$E_{cm}$	TeV 1.00E+34	1.5	1.5	1.5	3
Luminosity	$\mathcal{L}$	cm <sup>2</sup> /s	2.7	1	1	3.4
Muons per bunch	$N_{\mu}$	1.00E+12	0.1	1	2	2
No. bunches (each charge)	$n_b$	Integer	10	1	1	1
Ring circumference	C	km	2.3	3	3.1	4.5
Betatron ampl. function	$\beta^*$	mm	5	10	10	5
Momentum Spread	$\Delta p/p$	%	1	0.1	0.1	0.1
Ring depth	D	m	35	13	135	
Muon survival		%	30	4	7	
Transverse emittance	$\epsilon_T$	$\pi \mu\text{m}$	2.1	12	25	25
Longitudinal Emittance	$\epsilon_L$	$\pi \mu\text{m}$	370,000	72,000	72,000	72,000
Proton rep. rate	$R_b$	Hz	65	24	15	12
Proton Power	P	MW	$\approx 4$	$\approx 6$	4.8	4.3

In the medium and high emittance concepts, the muons of each sign are packaged in the minimum number of bunches (one per cycle) and the emittance goal corresponds to the beam-beam limit. The repetition rates were chosen to be relatively low (from 12 to 24 Hz) to keep the proton driver beam power reasonable. In the low emittance concept, the muons are packaged into more bunches with much lower transverse emittances, fewer muons per bunch, and the repetition rate is higher.

The low emittance concept allows higher beta-function values in the final focus triplets and correspondingly lower beta values at the interaction regions (as small as a few mm). To benefit from this, the bunch length must be small:  $\sigma_Z < \beta^*$ . Note that the RF voltage needed for longitudinal focusing increases with decreasing bunch length:

$$V_{RF} \sim \alpha_c \epsilon_L^2 / \sigma_Z^4$$

where  $\sigma_p = \epsilon_L / \sigma_Z$  is the momentum spread and  $\epsilon_L$  is the longitudinal emittance. To keep  $V_{RF}$  within reasonable limits requires a very low momentum compaction factor  $\alpha_c$ . A low  $\alpha_c$  lattice creates strong chromatic perturbations which must be corrected over a wide

momentum range. In addition, given the large number of bunches, it will be necessary to either separate the beams in the parasitic IPs with the help of electrostatic separators, or resort to a two-ring scheme. On the other hand, the smaller number of particles per bunch would alleviate problems associated with the space charge and coherent instabilities all the way from the proton driver to the collider, and smaller transverse emittances would permit the use of lower acceptance accelerators.

Advocates for the low emittance concept have pointed out several advantages for this concept. Lower emittance allows for a reduction in the required muon current for a given luminosity, at least until the beam-beam limit is reached. This diminishes several problems:

- radiation levels due to the high energy neutrinos from muon beams circulating and decaying in the collider that interact in the earth somewhere off-site;
- electrons from the same decays that cause background in the experimental detectors;
- difficulty in creating a proton driver that can produce enough protons to create the muons;
- proton target heat deposition and radiation levels;
- heating of the ionization cooling energy absorber; and
- beam loading and wake field effects in the accelerating RF cavities.

A smaller emittance also:

- allows smaller, higher-frequency RF cavities with higher gradient for acceleration;
- makes beam transport easier; and
- allows stronger focusing at the interaction point since that is limited by the beam extension in the quadrupole magnets of the low beta insertion.

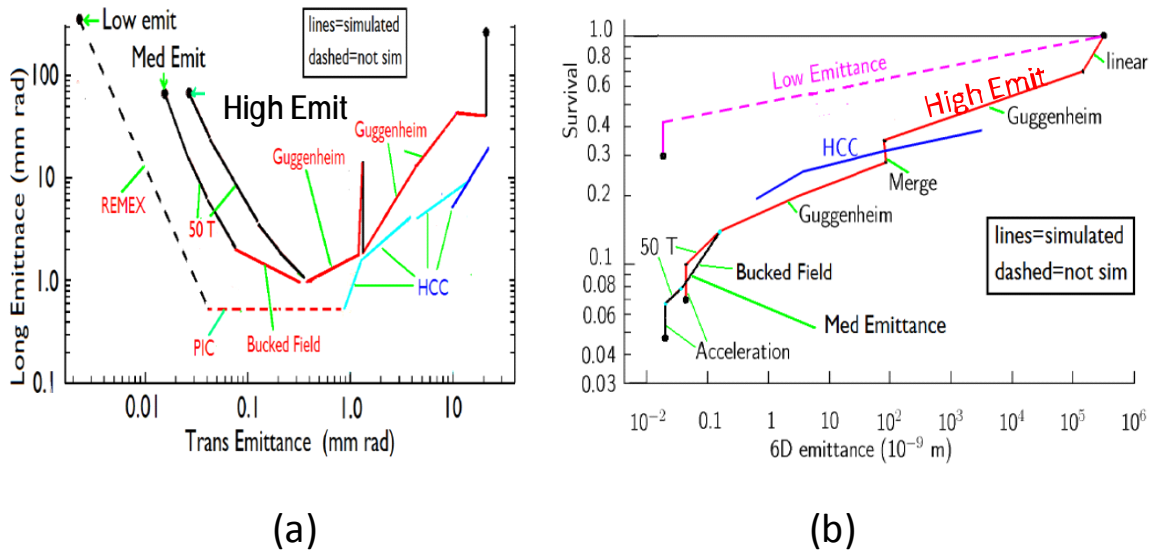
The medium and high emittance concepts require less cooling than the low emittance concept. The medium emittance concept, in addition, allows for cooling both positive and negative muons within the same cooling channel<sup>24</sup>. Cooling represents a major technical challenge to the feasibility of a muon collider, and as such, less aggressive cooling requirements may be a significant advantage for these concepts. The cooling scenarios for the three concepts of Table 3 are shown in Figure 5. The plots show the three scenarios, labeled “Low Emit”, “Med Emit” and “High Emit”.

Scenarios for the cooling sequences of the three concepts are represented in a Fernow-Neuffer plot in Figure 5(a). The scenarios evolve from right to left showing initial reduction of the transverse emittance and the longitudinal emittance until a minimum value of longitudinal emittance is reached, and then final reduction of the transverse emittance while the longitudinal emittance increases (emittance exchange). Throughout these scenarios cooling is a result of ionization energy loss, and the longitudinal

momentum loss is replaced by RF cavities in the cooling sections. In the low and medium emittance concepts, the initial cooling sections, labeled “Guggenheim”, consist of an open set of magnets, absorbers and RF sections arranged along a helical path. In the low emittance concept the initial cooling is achieved by a series of helical cooling channels (HCCs), in which the magnets, cooling media, and RF cavities are integrated within a single structure. After the minimum longitudinal emittance is reached, the medium emittance concept deviates from the high emittance scenario by the insertion of a “bucked field” stage, which further reduces the transverse emittance while the longitudinal emittance increases. Following this, the final reduction of the transverse emittance is achieved by a series of high (50T) solenoids. After the final cooling the muon beams are injected into the acceleration section of the collider.

The plot in Figure 5(b) shows the survival rate of muons vs the 6D emittance as reduced by the cooling stages, and through the acceleration and injection into the collider ring. The plot shows that the survival rate for the low emittance concept is significantly higher than that for the other two concepts, although a complete end-to-end simulation including the final “extreme cooling” required for a muon collider has not been done.

An end to end simulation of the three stages of the HCC system of the Low Emittance scenario has been done with encouraging results as shown in Figure 5(c). The high gradient allowed by the pressurized cavities, even in the presence of strong magnetic fields, and the fact that the acceleration and energy absorber occupy the same physical space make a compact cooling channel. The HCC is based on a theoretical model<sup>25</sup> that has been essential for successful simulation work. The good cooling and low losses imply that the beam that followed from this HCC system could be matched to and accelerated in the same linac that drives the protons. The development of muon cooling for a neutrino factory to use this approach would make the neutrino factory a better intermediate step towards an energy-frontier high-luminosity muon collider.



**Figure 5: Comparison of cooling scenarios of the three design concepts: (a) Fernow-Neuffer plot, (b) muon survival vs. 6D emittance.**



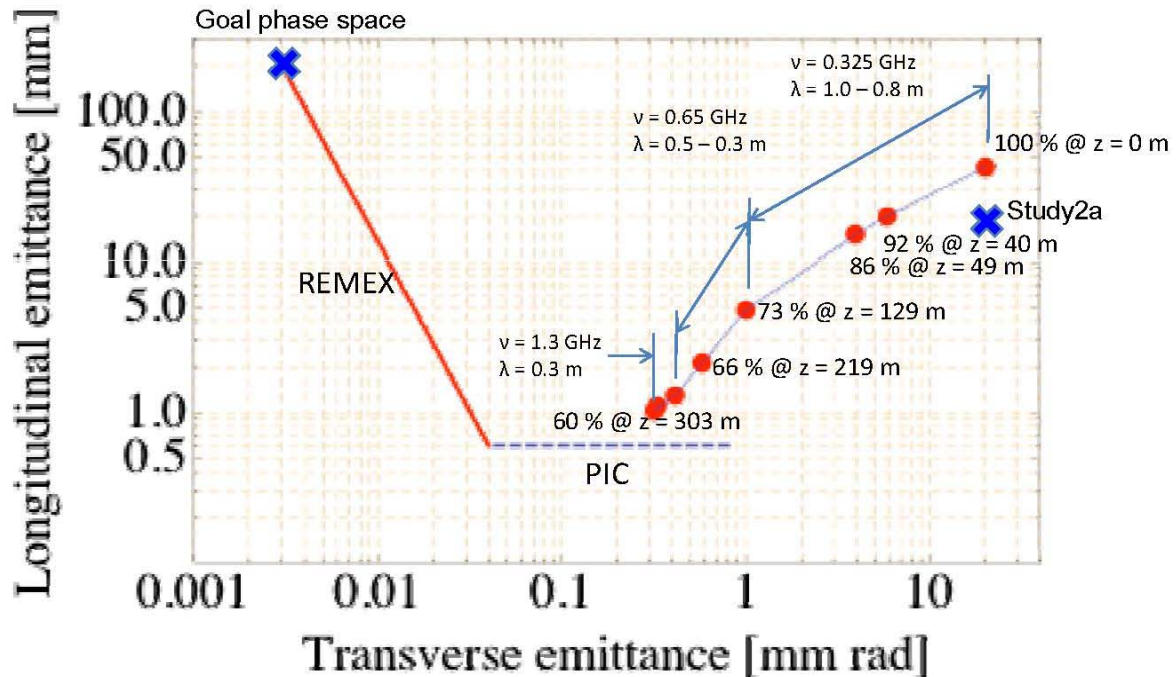


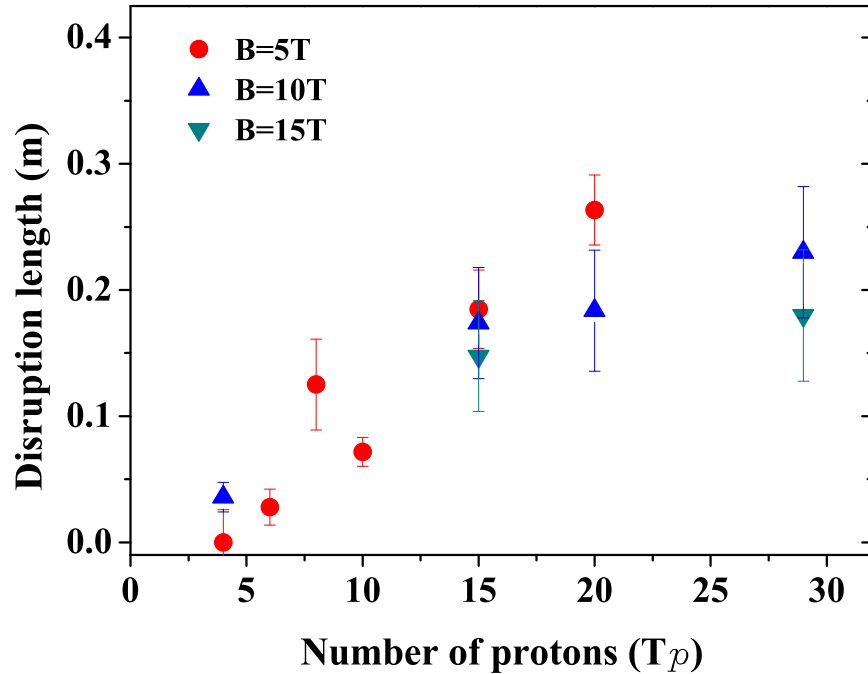
Figure 5c: Latest HCC 6D muon cooling simulation results by Yonehara et al.<sup>26</sup> based on engineering conceptual designs. The red dots show the emittance evolution of the simulation results<sup>27</sup> assuming parameters of pressurized RF cavities with dielectric inserts by Neubauer et al.<sup>28</sup> and the HTS magnets being prototyped in the Fermilab TD by Zlobin et al.<sup>29</sup>. A factor of more than  $10^5$  reduction of 6D emittance takes place in 303 m with 40% loss of muons, which could be somewhat mitigated by a factor of two better transverse acceptance in each plane compared to Neutrino Factory Study 2a. Such high efficiency implies that a neutrino factory muon beam could be cooled well enough to use the Project-X linac for muon acceleration.

### 2.3.3 Power and Beam Structure Requirements for the Proton Source

In the previous section three schemes for realization of a muon collider have been described, based primarily on different concepts for reducing the emittances. In this section we shall focus on the interactions between the various parameters and tradeoffs that can be made to optimize the performance, cost, and other quantities relevant to the Project X alternatives.

Parameters such as the number of particles per bunch, the number of bunches in the collider ring, the repetition rate, and the beam power can be varied within limits so that the desired luminosity can be achieved. Emittance, particularly transverse emittance, also has an impact on the other parameters, as shown in Table 3. With lower transverse emittances the number of particles per bunch can be reduced while raising the number of muon bunch pairs per second, for example.

The limitations on the repetition rate are linked to the proton beam power and the effect of the proton beam on the target. For a liquid mercury target as used in the MERIT experiment<sup>30</sup>, the liquid mercury jet could be disrupted by the beam, and once disrupted, the production of pions might diminish. Their results showed that the pion production was not appreciably reduced, even when the target was disrupted. As shown in Figure 6, the disruption length of the mercury jet depends on the beam intensity and the strength of the solenoidal magnetic field surrounding the target, as well as the beam energy. It is interesting to note that there is a threshold intensity below which the target is not disrupted.



**Figure 6: Results of the MERIT experiment, for 14 GeV protons.**

Operation in a 15 T magnetic field mitigated the disruption of the target. For tests with 14 GeV protons at CERN, 20  $T_p$  ( $2 \times 10^{15}$  protons) produced a disruption length of 0.2m. That disruption length together with the velocity of the mercury jet implies that repetition rates up to 70 Hz are acceptable because the disrupted part of the jet moves downstream by one disruption length in about 14 msec. Operation under conditions corresponding to a beam power as high as 8 MW was demonstrated. The MERIT results showed that targeting is feasible for all three muon collider scenarios.

### 3 Facility Concepts

(Adapted from references 1,2 )

#### 3.1 IC-1 Linac

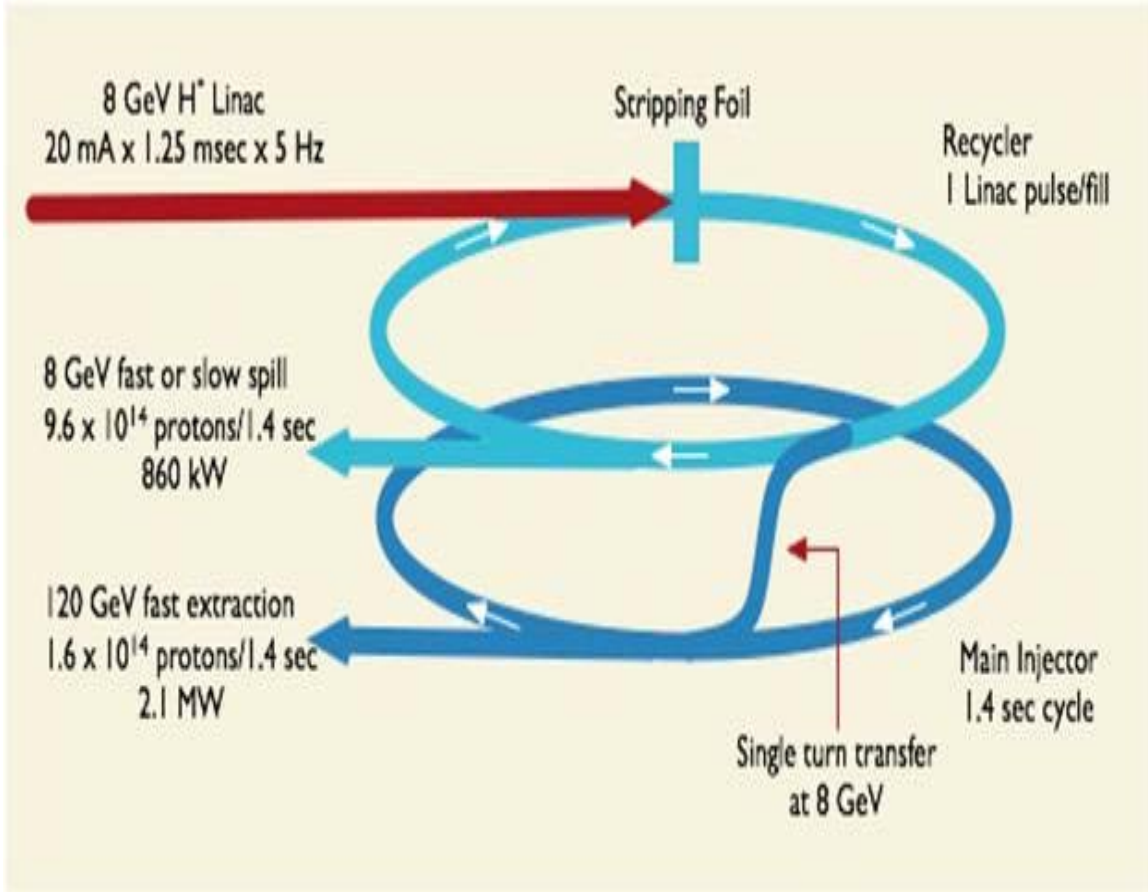
The IC-1 configuration is designed to meet the needs of the proposed intensity frontier program. It is based on accelerating  $H^-$  in an 8 GeV (ILC-like) pulsed linac (20 mA) and injecting directly into the recycler. The recycler would provide 8 GeV, fast or slow spill with  $4 \times 10^{14}$  protons/1.4 sec, giving a 360 kW beam. Besides the beam from the Recycler to an experimental program using 8-GeV protons directly, there would also be the capability for single turn transfer at 8 GeV to the Main Injector. The Main Injector would allow for fast extraction of  $1.6 \times 10^{14}$  protons at 60-120 GeV with cycle times corresponding to about 2 MW of proton beam power. This approach would be somewhat synergistic with the development of ILC technology. IC-1 was designed to satisfy the following criteria: it must provide 2 MW of a single turn extracted beam from the Main Injector with energies ranging from 60-120 GeV, and it must be able to provide 150 kW of 8 GeV beam to the Accumulator/Debuncher for the Mu2e experiment.

Modifications to the Recycler Ring to support Project X include integration of an  $H^-$  injection system, a new RF system, a new extraction system, and measures to mitigate electron cloud effects. The Main Injector would also need a different RF system and measures to preserve beam stability through transition.

##### 3.1.1 General Configuration

For completeness we include here the major subsystems for IC-1 and their specifications. The major subsystems are as follows:

- A front end linac operating at 325 MHz.
- An 8 GeV linac operating at 1300 MHz.
- An 8 GeV transfer line and  $H^-$  Injection system.
- The Recycler operating as a stripping ring.
- The Main Injector acting as a rapid cycling accelerator.
- Beam Instrumentation
- Conventional Facilities
- Controls
- Cryogenics



**Figure 7: Schematic layout of the accelerator configuration of IC-1.**

### 3.1.1.1 325 MHz linac Requirements

The Low Energy linac comprises the front end of the proposed 8 GeV Project X linac; it includes the ion source and the entire accelerator upstream of the 1.3 GHz cavity sections. The Low Energy linac is required to deliver 1.25 ms pulses of  $1.6 \times 10^{14}$  H<sup>+</sup> ions at 420 MeV and at pulse repetition rates up to 5 Hz. The output beam must conform to transverse emittance and longitudinal bunch parameters required for matching into the 1.3 GHz High Energy linac. Beam halo must be controlled to prevent unacceptable beam losses at high energies. The 1.25 ms pulse must incorporate a Recycler RF bucket frequency structure to facilitate bunch-to-bucket transfer and also a Recycler revolution frequency structure to provide an abort/extraction gap in the Recycler ring.

### 3.1.1.2 1300 MHz linac Requirements and Configuration

The 1300 MHz linac is a superconducting linac that can support a beam current of 20 mA, a pulse length of 1.25 ms, and a repetition rate of 5 Hz up to an energy of 8 GeV. It is designed to accelerate H ions and preserve the macro and micro bunch structure created in the 325 MHz linac.

The high-energy linac consists of two distinct parts: the energy range (0.42-1.2 GeV) using cavities optimized for  $\beta=0.81$  and the energy range (1.2-8 GeV) using  $\beta=1$  optimized cavities. The cavities will be variants on those designed for the ILC. A gradient of 25 MV/m was chosen for the initial configuration of the  $\beta=1$  section. This is readily achievable with current Superconducting RF (SRF) technology. The RF pulse length is 1.5 ms/pulse at 5 Hz, with a 1.25 ms beam pulse. It has been proposed to use 8 cavities in all of the cryomodules (CM), as in the ILC design. This choice has the advantage that all CMs are interchangeable. To handle the increased beam current, one klystron per 2 CMs was proposed. The klystron choice is the 10 MW multibeam klystron developed for the DESY XFEL and the ILC. The longitudinal dynamics of the non-relativistic H beam and possible cavity field variations over time (as seen in the SNS) will require use of vector modulators throughout the linac.

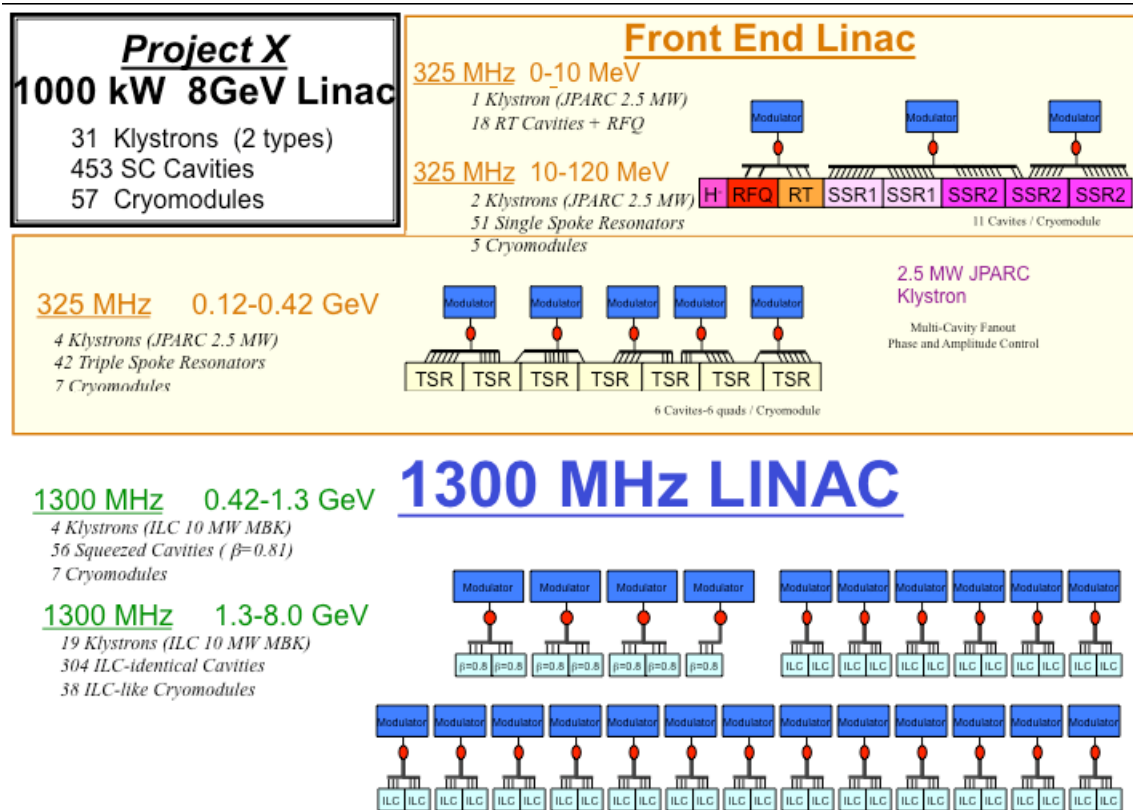


Figure 8: IC-1 Linac.

### 3.1.2 IC-1 Operation

In the initial operational scenario, the facility provides beam to two users, the long baseline neutrino oscillation experiment and the muon-to-electron conversion experiment. For the long baseline neutrino experiment, a single linac pulse delivers  $1.6 \times 10^{14}$   $H^-$  ions to the Recycler, where they are stripped and stored before a single turn transfer of  $1.6 \times 10^{14}$  protons to the Main Injector. The Main Injector ramps to 120 GeV and delivers the beam through a single-turn fast extraction to a transport line. This cycle repeats every 1.4 seconds. If lower energies down to about 60 GeV are desired, the Main Injector cycle time can be reduced to maintain approximately the same beam power. For the muon-to-electron conversion experiment, a total of  $8 \times 10^{13}$  protons are delivered from the Recycler to the Accumulator in three 15 Hz pings (each 1.6  $\mu s$  long) every 1.4 seconds. The Accumulator stores and momentum stacks the incoming pings and does RF beam manipulations before transfer to the Debuncher for slow extraction. The extraction system will provide the flexibility to vary the delivery scheme to the Accumulator in the event that space-charge limitations arise in that machine. Note that in the initial scenario only two out of every seven linac pulses are used. The unused pulses are available for other users, future upgrades, and/or maintaining 8 GeV beam availability while operating the Main Injector at energies below 120 GeV. For this operating scenario, and to meet the technical goals, the following assumptions are made about the state of operations at Fermilab for the initial configuration:

- The existing Linac and Booster will not be operational once Project X becomes operational.
- The existing Tevatron and supporting utilities will not be operational.
- The existing test beam facility in Meson, based on 120 GeV beam from the Main Injector, will remain available at low duty factor.
- The existing antiproton source will be reconfigured and operating in support of the muon-to-electron conversion experiment when Project X becomes operational.
- A neutrino beamline directed towards DUSEL will be operating with beam power on target of 700 kW, with shielding and infrastructure designed to accommodate up to 3 MW, as Project X becomes operational.
- The interface to the DUSEL beamline is defined as the Main Injector extraction kicker and the interface to the muon-to-electron conversion experiment is the Recycler extraction kicker.

### 3.1.3 IC-1 upgrade path(s)

The upgrade path for a high intensity beam supporting a possible future neutrino factory or a muon collider is foreseen by increasing the repetition rate, the linac pulse length, and/or the beam current. Various values of these parameters have been discussed in

combinations having the potential to achieve a beam power of approximately 4 MW at 8 GeV. The linac hardware, conventional facilities, cryogenic plant, and utilities will be designed to accommodate these upgrades.

### 3.2 IC-2 Linac

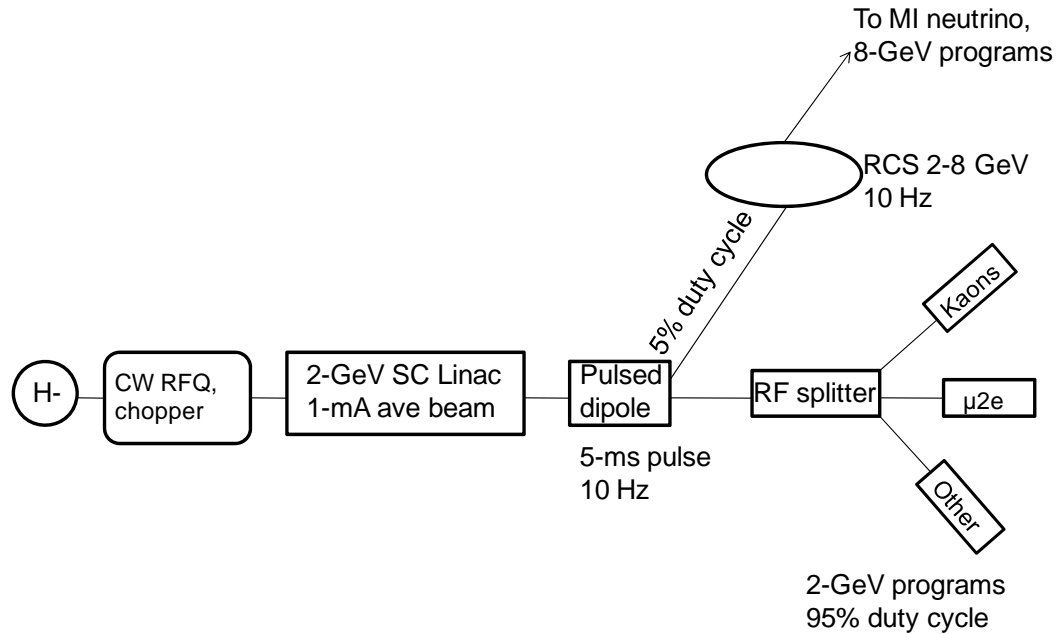
(Adapted from reference 2)

The main concept of the IC-2 is to replace the slow extracted beam at 8 GeV with the beam accelerated in a Continuous Wave (CW) linac operating with a nominal bunch repetition rate of 162.5 MHz. This concept has a number of advantages. First, the RF separation of the beam after acceleration allows simultaneous operation of several experiments. The time structure and the intensity of each beam can be varied independently by using a bunch chopper at low beam energy (~2 MeV). Second, the beam quality of a CW linac is significantly better than for slow-extracted beams; in particular, the linac beam intensity does not have fluctuations inherent to slow extracted beam from a synchrotron. Third, the power of beam accelerated by a CW linac is set by high energy physics requirements (ability to use this power by experiment) rather than by technical or accelerator physics requirements. Fourth, the bunch length in a linac (<10 ps rms) is much smaller than can be reasonably achieved in a ring, which enables unprecedented Time-Of-Flight resolution that will be invaluable to some next generation rare-decay experiments.

The energy of the linac is determined by the threshold of particle production. A linac energy of 1 GeV would be sufficient for pion production but the threshold of kaon production is slightly below 2 GeV. This sets the linac energy to at least 2 GeV<sup>2</sup>.

Note that IC-2 is based on a 1mA, 2-4 GeV CW linac; the specific energy will be set by the kaon production threshold. Studies of the energy choice with respect to the production threshold are underway<sup>31</sup>. After the CW linac section there is RF separation of the beam, which allows the servicing of a low energy experimental program in parallel with a higher energy physics program. The RF separation will provide the low energy program with 2 MW of beam power with the appropriate bunch structure. Further acceleration of the beam would allow injection into one of the existing Fermilab rings. The Accumulator, Debuncher, Recycler, and the Main Injector all have 8 GeV injection energies. Increasing the energy of the beam after the RF splitter introduces a fork in the conceptual design. In IC-2 the beam from the CW linac needs to be accelerated to 8 GeV for injection into the Recycler. This additional acceleration can be achieved by adding a pulsed linac (10 Hz), which accelerates the beams up to injection energy, or by a rapidly cycling synchrotron (RCS). For the RCS the injection takes place with foil stripping for 4.2 ms at 1mA. The recycler is filled with 6 RCS pulses at 8 GeV. The beam current of 1 mA is set by the compromise between issues associated with beam injection into the RCS or Recycler/Main Injector with a low current and maintaining reasonably small total power. Injection would be easier with a larger current; however, it is possible that there are no users capable of using the larger power. The remainder of IC-2 looks much like IC-1; it is

included here for completeness. The recycler can provide an 8 GeV fast spill with  $2.1 \times 10^{14}$  protons every 1.4 seconds, giving 190 kW beam power. There is a single turn transfer to the Main Injector (at 8 GeV). The Main Injector provides 120 GeV fast extraction with  $1.6 \times 10^{14}$  protons every 1.4 seconds, giving a 2 MW beam power.



**Figure 9: Schematic layout of the accelerator configuration for IC-2**



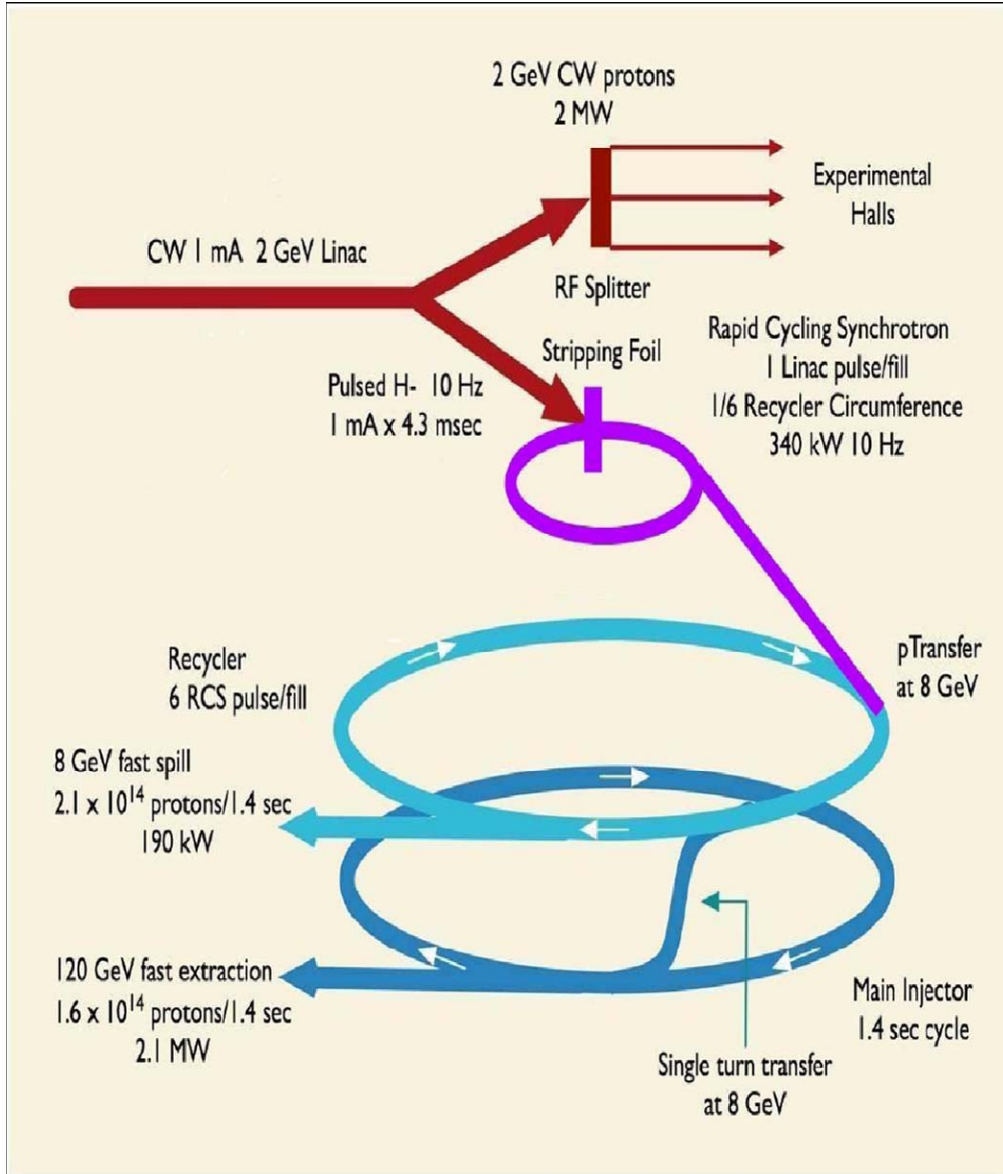


Figure 10: schematic layout of the accelerator configuration of IC-2

### 3.2.1 IC-2 Operation

IC-2 goes beyond the ability of IC-1 to satisfy the needs of the proposed intensity frontier program. The key difference is the flexibility to provide beam to multiple low energy experiments. Its upgrade path will be discussed in Section 5.

## 4 Additional Facilities Needed for Either Facility Concept

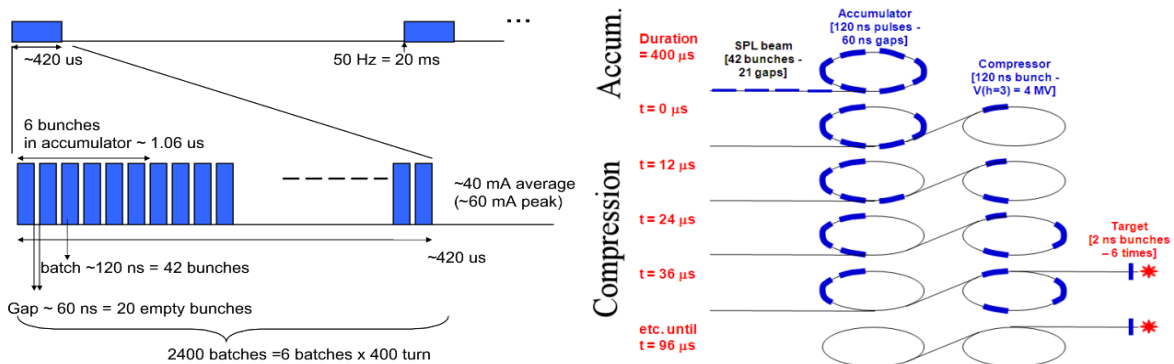
The proton source for a neutrino factory must provide a large amount of power, of the order of 4 MW, at an energy large enough to produce pions copiously. The exact energy of the beam is under discussion, with possibilities ranging from  $\sim 3$  GeV to 8 GeV. As emphasized previously, not only do the proton beam bunches need to be intense, they also need to be short because the process of capturing muons in RF buckets downstream of the target<sup>32</sup> relies on the correlation between momentum and arrival time that develops after a lengthy drift space. An rms bunch length of 1 ns is preferred, but 2 or 3 ns is considered acceptable; the captured muon flux drops by about 5% for bunch lengths of 3 ns compared to 1 ns. This is a challenging goal given the number of protons required per bunch. The following section discusses extensions to Project X to make it compatible with both a neutrino factory and muon collider. The parameter sets for the neutrino factory and muon collider are somewhat different. In order to keep open the possibility of using Project X to drive both, we aim for a very flexible concept. For the next studies relevant to P-X, we will propose to reexamine the plans for a neutrino factory, which would be sited at Fermilab and be based on much more muon cooling than was used in any previous neutrino factory studies, including the ISS, BNL and Fermilab works. This approach would have the benefit of making a neutrino factory a more relevant intermediate step toward a muon collider.

In order to achieve the flexibility and intensity required to make Project X compatible with both a neutrino factory and a muon collider, the use of two rings, much like the CERN Super Conducting Linac (SPL)-based neutrino factory concept<sup>33,34</sup>, appears to be a promising approach. A two-ring neutrino factory scenario specific to Project X has also been studied<sup>35</sup>. This combination of the Project X specific scenario and the SPL-based neutrino factory concept are the basis of the discussions in this section. There are several options regarding the choice of proton rings for a Project X upgrade. The details regarding beam injection into a ring depend on how the beam is delivered and is therefore coupled to the linac configuration, see sections 3.1 and 3.2. Conceivably, if one had a pulsed linac up to 8 GeV then the beam could be directly injected into the Main Injector, as discussed in the aforementioned sections. In this scenario the Main Injector and a linac could constitute the proton driver for a neutrino factory/muon collider. This approach has significant power limitations associated with it. To increase the power output of the system one could accumulate protons in the recycler then use a single turn transfer to the Main Injector, which would allow the power to be increased to  $\sim 2$  MW. However, most studies indicate that 4 MW is required for neutrino factories and muon colliders<sup>36</sup>. In either case, studies are needed to show how to use the Main Injector to achieve rms bunch lengths less than about 3 ns with  $\sim 10^{14}$  protons per bunch.

There are numerous two-ring scenarios that could be used in conjunction with Project X to provide the flexibility and intensity needed to make Project X compatible with a neutrino factory or muon collider. One could envision using the existing Recycler, pbar Accumulator and/or pbar Debuncher to drive a neutrino factory. Again, one would need

to study the ability of the rings to provide very short bunches. The key requirement of any two ring scenario is the ability for it to provide flexibility (including repetition rate etc) and very short intense bunches on the pion production target. The remainder of this section tries to identify the most promising two ring scenario. The ring options are discussed somewhat independently of the specific linac configurations of IC-1(2). For definiteness it is assumed that the beam from the linac will be chopped and a “bucket-to-bucket” injection scheme can be used. Details of injection will be discussed later.

As a guide we consider the studies that have been performed for the CERN SPL-based neutrino factory concept, as they provide something akin to a proof of principle. CERN’s SPL-based neutrino factory study proposes using two fixed-energy rings to deliver 4 MW beam at 5 GeV for a neutrino factory that is compatible with ISS specifications. A pulsed linac (the SPL) accelerates the H<sup>+</sup> beam to 5 GeV. The beam is then injected into the first of the two rings. The first (Accumulator) ring is isochronous and has no RF, thus avoiding the introduction of additional narrow band impedance into the system. However, there will still be a broad band impedance contribution from the beam pipe and magnets etc. The Accumulator ring can accommodate up to six 120 ns long bunches. The second (Compressor) ring can accommodate 3 bunches at a time from the Accumulator. The Compressor ring uses large RF voltages for bunch rotation (large stored energy and minimum RF power), the bunch rotation is performed using the energy stored in the RF cavities. The second ring has a large slip factor ( $\eta$ ) to facilitate rapid phase rotation ( $\sim 10 \mu\text{s}$ ). This setup can achieve  $\sim 2$  ns rms bunch lengths at extraction. The ratio of circumferences between the accumulator and compressor ring guarantees the positioning of successive bunches in the compressor ring without changing the energy in either ring. The following sections discuss some of the issues associated with the rings in a generic linac plus two ring Project X upgrade. The discussion parallels much of the work done for the SPL-based neutrino factory.



**Figure 11: Principle of bunch generation with a linac-based proton driver after Garoby *et al*<sup>33</sup>.**

We now move on to a more detailed discussion of a two-ring scenario. The general concept is similar to that of the CERN SPL. The first ring, the Accumulator, would have just enough broadband RF to provide some barriers to preserve gaps between bunches.

No bunch compression would be done in the Accumulator. The Accumulator could therefore be a high-quality, simple storage ring with excellent beam stability. Having no beam manipulation in the Accumulator ring will help maintain flexibility in the overall design. All bunch compression would be performed in the second (Buncher) ring. The method used for compression will be discussed in more detail below. Given the pulse specifications (Tables 2 and 3) the Buncher ring may be very challenging to design. The Accumulator will probably be run below transition to enhance beam stability, but close enough to transition to make it feasible for broadband RF systems to form barrier buckets. Whether the Buncher ring runs below or above transition depends in part on the bunch compression scheme that is chosen. In some compression schemes a  $\gamma_T$ -jump may be required in the Buncher ring. Hopefully the need for this could be avoided.

## 4.1 Accumulator Ring

In this section we discuss some of the ideas/issues associated with an accumulator ring. Many of the details will also apply to the bunch-shortening ring. The one Accumulator-specific issue we cover here is injection. Other issues, such as space charge effects and electron cloud instability are applicable to both the Accumulator and the Buncher. Several of these issues, space-charge effects in particular, may be more critical in the Buncher, as this is where the most severe bunch requirements exist. Space-charge effects will play a role in how the bunch compression is achieved. Issues associated specifically with bunch compression schemes are discussed below. While most of the discussion is general, there is an implicit assumption that the incoming beam from the linac will be chopped to allow clean injection into existing RF buckets to form the desired number of bunches.

The Accumulator ring contains broadband RF systems that create  $N$  quasi-rectangular barrier buckets<sup>37</sup> to contain  $N$  bunches in the first ring. The linac beam would be chopped so no beam lands on the barriers, i.e. near the unstable fixed points of the buckets. The beam could all be injected on-momentum, i.e. no longitudinal painting, or off-momentum, if we want to paint longitudinally to a somewhat larger longitudinal emittance than what is implied by the momentum spread of the beam from the linac (debunched if necessary) and the time length of a bucket. The resulting distribution of particles in the buckets is close to ideal for rotation in the second ring; after rotation, the beam current of each bunch would be close to a rectangular pulse.

A full energy linac plus Accumulator/Buncher ring scenario allows current to be accumulated in a ring to form a few intense bunches, a format that cannot be achieved by a linac alone. Since it is expected that the injection will be done via charge-stripping of the H<sup>-</sup> beam, we need not worry about the limitations coming from Liouville's theorem on the number of particles (turns) that can be injected. The limitations in the number of particles that can be injected are likely to arise from space charge effects, foil heating and damage, and beam stability issues in the ring.

It is possible that future developments may allow new methods of charge-stripping injection, e.g. laser stripping. For this report it is assumed that a stripping foil will be used

because that is an established technique, albeit one that must be extended to enable injection of several megawatts of beam into a relatively small ring. The  $H^-$  ions enter the ring through a foil that strips away the two unwanted electrons. Not all of the  $H^-$  ions are stripped cleanly; partially stripped  $H^0$  and unstripped  $H^-$  need to be directed to a beam dump. One of the advantages of this type of accumulation is the ability to overlap regions of phase space and thereby inject into a specified emittance over a large number of revolutions. This is important as the emittance from the linac will be  $\sim 1 \pi$  mm-mrad. The distribution of particles in the ring can be "painted" by adjusting the position of the closed orbit of the circulating protons as they pass through, or near to, the foil.

Due to the intensity of the bunches it is expected that very large transverse emittances will need to be prepared in order to control space-charge forces. Painting at injection will be necessary in the 4D transverse phase space and possibly also in longitudinal phase space. Painting injection can be performed with vertical and horizontal bump-magnets. The proton orbit can be moved close to the stripping foil at the beginning of injection to create a circulating beam that populates the central region of the transverse phase space. The initial orbit displacement, which corresponds to the maximum bump-magnet field, is subsequently reduced, allowing for the painting of the beam across the accelerator aperture with the required emittance. If the beam current is low the stripping may need to take place over many turns in order to accumulate the required charge. The feasibility of multi-turn stripping (for a large number of turns) is discussed in Appendix 2.

One idea described in Appendix 2 is the Resonant Foil Bypass concept. It makes use of some of the technology developed for beam extinction in the Mu2e experiment<sup>38</sup>. It uses two resonant dipoles to create a "local bump" in the beam orbit in addition to the more slowly varying dipoles used for painting. The fast orbit displacements would be synchronized with a high-frequency periodic chopping of the linac beam. The beam would be bumped away from the circulating orbit toward the foil only when the  $H^-$  beam is present for injection. This makes it less likely that circulating protons will traverse the foil when there is no beam actually being injected. This injection scheme, combined with painting to large transverse emittances and the other ideas described in Appendix 2, make it plausible that a very large number of turns can be injected into the Accumulator. The full scheme must be simulated, and the results of the simulation used to optimize the process.

Several effects associated with intense beams circulating in the rings require consideration. The detailed analysis of such effects is a job for the experts. This report considers mainly space-charge effects because the estimation of space-charge tune shifts is relatively straightforward and because such effects usually represent the ultimate limit on performance; other intensity-dependent effects can often be mitigated more readily than space charge. Space-charge effects will be especially important in the Buncher.

### 4.1.1 Space-charge Tune Shifts

If the charge density of the bunches becomes large, the Coulomb force between the particles within a bunch cannot be ignored. The resulting space charge force causes a shift in the betatron tunes. The tune shift will act in both the horizontal and vertical planes. Additionally, the longitudinal focusing effect of the RF forces will be modified by the space charge forces. The betatron tunes of transverse oscillations of charged particles in a beam are determined primarily by the focusing forces associated with quadrupoles. The tune will be shifted by both the direct space charge and the forces due to induced images in the surrounding structures. In general one usually tries to keep the tunes away from low order resonances. The space-charge tune shift parameter is conventionally used as a measure of the seriousness of these effects. It is given by

$$\Delta\nu = -(3N_p r_p) / (2\epsilon_n \beta \gamma^2 B),$$

where  $r_p = 1.535 \times 10^{-18}$  m (the electromagnetic “radius” of the proton),  $\epsilon_n$  is the normalized emittance containing 95% of the beam,  $\beta$  and  $\gamma$  are the usual Lorentz kinematical factors, and  $B$  is the bunching factor (defined as the ratio of average beam current to peak current). Tune shifts less than about 0.3 are typically considered acceptable for proton rings. We now consider a numerical example of tune shifts using the existing booster ring as a baseline<sup>39</sup>. If one requires 250  $T_p$  in a 3ns bunch in the Booster, the tune shift will be  $\Delta\nu = 4.2$ , which is unacceptable based on the aforementioned “limit”. If a smaller ring is used instead of the Booster, a ring with a circumference 1/5 of the Booster size (implying a magnet change from 1T to 5T), a more favorable bunching factor can be achieved. The tune shift in such a ring would be  $\Delta\nu = 0.9$ , which is still large. If the single bunch could be split into 4 bunches the tune shift could be reduced to  $\Delta\nu = 0.22$ . Thus a multi-bunch scenario can be used to bring the tune shift associated with having very intense bunches to an acceptable level. The results are summarized in Table 4. Additionally, the multi-bunch scenario can be made to look like a single bunch scenario at the target by recombining the bunches as they hit the target. A possible recombination scheme is discussed in section 4.3. Preserving the single very intense bunch, at least at the target, may be crucial for satisfying the muon collider design specifications.

### 4.1.2 e-p Instability

In addition to the issues associated with space charge, there are other instabilities that need to be considered. Some of these will depend on the intensity and the energy of the beam. The electron cloud instability arises from the proton beam interacting with electrons in the vacuum chamber. The electrons come from the ionization of residual beam gas by the proton bunches. The electrons that come from the trailing edge of a passing proton bunch quickly make their way to the vacuum chamber wall. The interaction of the electrons with the wall leads to further electron production. The particles can remain in the chamber long enough to interact with subsequent proton

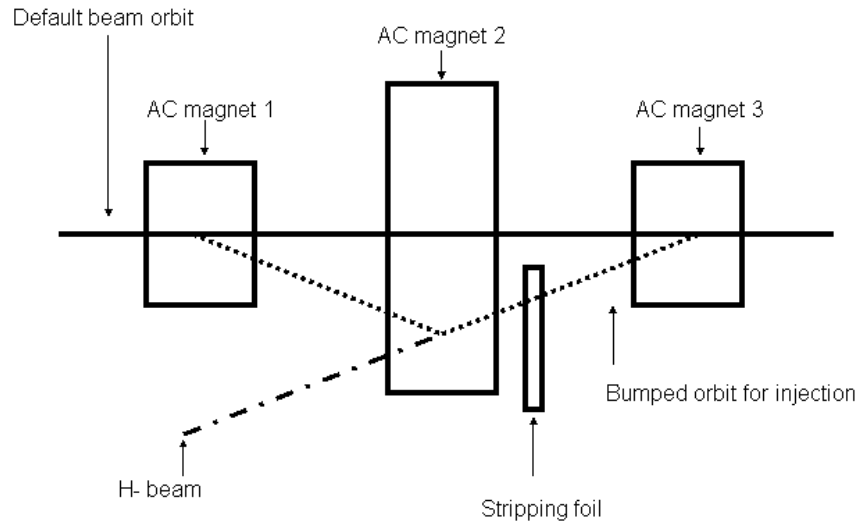
bunches. This can lead to emittance growth, beam instability, and possibly beam loss. The electron yield depends on factors such as proton beam intensity, bunch spacing, secondary emission rates, and gas pressure. There are several ways to help mitigate the problem, including lowering vacuum pressures and coating the vacuum chamber walls with materials such as titanium nitride to reduce secondary electron emission.

Ring	E (GeV)	C (m)	N (Tp)	P (MW)	$\sigma_z$	$\epsilon_N$	Nb	$\Delta v$
Booster	8	474	250	4.8	1	112	1	4.2
SC	8	100	250	4.8	1	112	1	0.9
SC+Trombone	8	100	250	4.8	1	112	4	0.22

**Table 4: Summary of tune shifts for some 8 GeV ring options**

### 4.1.3 Many Injection Turns

The subject of accumulating protons in the Accumulator is discussed in Appendix 2. One new concept described there, “resonant foil bypass”, is illustrated in Figure 12. The AC dipoles modulate the beam orbit at the foil at the same frequency as the incoming beam. Additional dipoles, not shown, would be used for conventional painting to create large transverse emittances in order to alleviate space charge.



**Figure 12: “Resonant foil bypass” uses two or three resonant dipoles to create a “local bump” in the beam orbit. The beam is bumped closer to the foil only when the H<sup>-</sup> beam is present for injection. This helps to prevent the circulating proton beam from traversing the foil when the incoming beam is “off”.**

## 4.2 Bunch Rotation Ring

For both a neutrino factory and muon collider it is desirable to have short and intense bunches impinging on the target. This is important for the efficient production of muons and neutrinos. As discussed in section 4.1.1, a multi-bunch scenario may be needed to manage tune shifts in the rings. Employing the multi-bunch approach means the bunch rotation ring must be able to accept multiple bunches from the Accumulator and format them to satisfy the muon collider beam specifications at the pion production target. For definiteness we assume the multi-bunch scenario here.

Injection from one ring into another can be done “bucket-to-bucket”: the RF systems of the two machines are phase locked, and the bunches are transferred directly from the buckets from one ring into the buckets of the other. The Accumulator ring in the current scenario has minimal broad band RF to create bucket barriers. The second ring, the Rotator, will have more RF as it will be needed to perform bunch rotation. The bucket to bucket transfers can be efficient provided that:

- The injected beam hits the center of the bucket in the receiving machine.
- The rings are longitudinally matched, ie/ they have the same  $\beta$ -function, this determines the aspect ratio of the longitudinal ellipse in phase-space.

If the injected beam misses the center of the Rotator ring bucket, the injected beam will rotate in the bucket. The bunch rotation and the nonlinear phase-space trajectories will most likely result in filamentation and emittance growth.

There are several methods that can be used to achieve short bunches. It is not entirely obvious which is the best option given the intensities required for a neutrino factory or muon collider. Whichever approach is chosen it envisioned that the chosen method will be implemented in the second ring.

If barrier buckets are used to form the bunches, as seems likely, then they can be approximately rectangular in longitudinal phase space. The buckets in which these bunches rotate in the second ring can be linearized out to about 90 degrees from the center, allowing a clean rotation to a short bunch. Garoby has discussed how to deal with beam loading effects in a two-ring system in connection with his design ideas for a neutrino factory. This approach is likely to work; however, for completeness, other approaches are discussed in the following paragraphs.

The most straightforward way to achieve shorter bunches with resonant RF cavities is to reduce the voltage to a small value. If this is done adiabatically then the bunch will stay matched to the bucket. When the RF voltage is restored in a time much shorter than a synchrotron cycle, the mismatched bunch will rotate in the bucket. After a quarter of a synchrotron period, the bunch will be narrow and have a large energy spread.



There are alternative bunch rotation schemes that may provide a path to achieving short bunches. In the multi-bunch scenario the Rotator ring would have to be able to accept multiple bunches from the Accumulator and perform bunch rotation in longitudinal phase space to shorten the bunches prior to extraction. During this operation, the momentum spread will become large, of order a percent. The large expected momentum spread suggests that the Rotator ring will need to have a large momentum acceptance. The effect of momentum spread is discussed in more detail later in the section. Also, the space-charge tune shift will be large when the beam is short; the effect will be strongest in the core of the bunch where the particle density is highest. In general, the minimum bunch length achievable is restricted by distortions of the bunch during the phase rotation. The rotation speed of a particle in a bunch is given by its synchrotron tune:

$$v_s = (h\eta eV \cos\phi_s / 2\pi E)^{1/2},$$

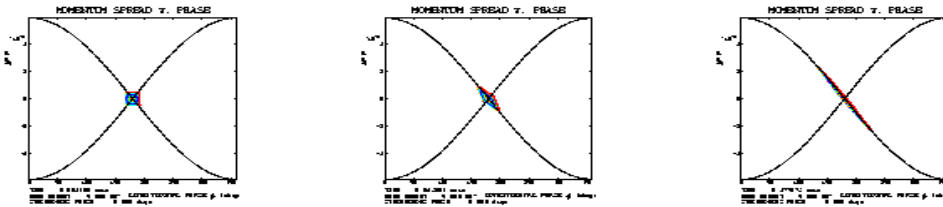
where  $eV$  is the maximum energy gain per turn,  $\phi_s$  is the synchronous phase,  $h$  is the harmonic number,  $E$  is the energy, and  $\eta$  is the slip factor ( $\eta = \gamma_T^{-2} - \gamma^{-2}$ ). If the slip factor is large, the system is far from transition, and from the expression above we see that phase rotation can be accomplished quickly. The slip factor will only depend weakly on the energy when  $\gamma$  and  $\gamma_T$  are significantly different from each other. Therefore, distortions or variations in the synchrotron frequencies ( $v_s$ ) of the particles in a bunch will only be important if the bunch has a large momentum spread. Momentum spread typically accompanies phase rotation so this will play a role in some schemes.

As discussed in section 4.1.1, there are space-charge effects that need to be considered for such intense bunches. For very intense (short) bunches, the longitudinal space-charge forces will counteract the RF focusing force below transition. This reduces the synchrotron tune and slows down the rate of phase rotation. It is also possible that the space charge force for very intense bunches actually exceeds the RF focusing force, causing the particles to rotate in the reverse direction. This particular instability is probably somewhat theoretical as we are typically only interested in 1/4 of a synchrotron period. The modification of the RF focusing occurs primarily at the core of the bunch, where the charge density is the strongest. The slowing down of the rotation speeds for particles near the core allows particles near the separatrices to catch up. This results in fewer particles in the tail of the rotated bunch, which is desirable as it should result in a smaller bunch size. This benefit may be somewhat moot if the figure of merit is the rms length. Eventually, at very high intensities, the bunch lengthening effect of the space charge force will dominate any attempts at bunch compression for a ring below transition.

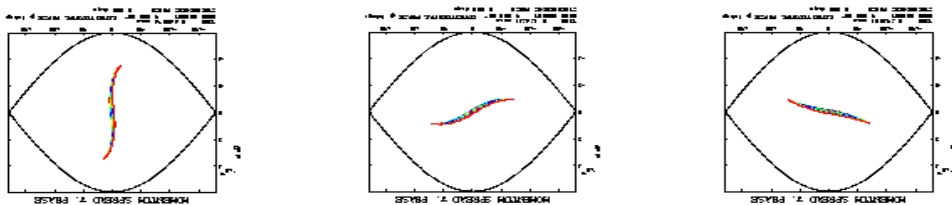
Depending on the energy of the rings being used, bunch rotation may give rise to the microwave instability. This is not expected to be an issue at the energies we are considering, 3-8 GeV.

As mentioned earlier there are several methods that can be used to achieve bunch rotation. Rotation can be achieved by shifting the synchronous phase from the bucket center to an unstable fixed point. The bunch is then allowed to spread out along the separatrix. Later, the synchronous phase is shifted back to the bucket center and the

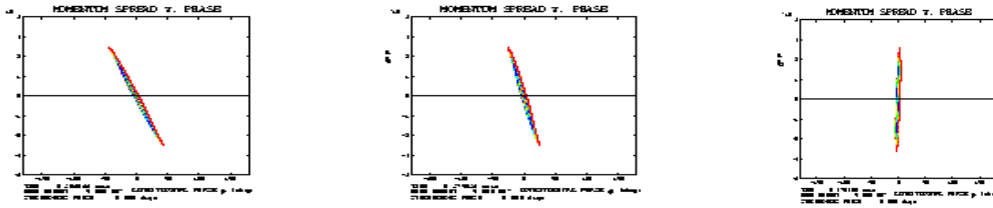
bunch is allowed to rotate in the longitudinal phase space, resulting in a compressed bunch. In this scheme the bunch will begin to see the non-linear component of the RF wave. This will be noticeable after rotation by the distortions at the top and bottom of what would otherwise look like an ellipse. This method and non-linear effect have been discussed in the context of an Accumulator and Compressor ring for a neutrino factory<sup>40</sup>. The following example<sup>33</sup> considers a two ring scenario for driving a neutrino factory. The first ring is below transition and the second ring is above transition. Phase rotation begins in the first ring; below transition ( $\eta < 0$ ), the beam will stretch along the bucket extremity, as shown in Figure 13. Switching the cavity phases to bring the beam onto the stable point then generates phase rotation. However, as Figure 14 reveals, the elongated beam will see the non-linear part of the sinusoidal cavity field and a distorted upright ellipse will result. The effects of seeing the non-linear part of the field can be mitigated by rotating the bunch in the opposite direction. This can be achieved by transferring it, once stretched, into a compressor ring operating above transition ( $\eta > 0$ ). The previous point implies that the rotation procedure is begun in the Accumulator ring and transferred to the Rotator ring for the final stage of the rotation. Figure 16 shows that a bunch of about 2 ns rms can be achieved.



**Figure 1 Stretching of a beam at the unstable fixed point below transition**



**Figure 2 Phase rotation below transition**



**Figure 15: Phase rotation above transition**

In the context of Project X, we expressed a desire to keep the Accumulator ring as free of beam manipulation as possible. In fact in the scenario described so far the Accumulator has very limited RF (and is below transition). It may be possible to achieve a similar bunch rotation effect (as that described above) by having the Rotator ring below transition for the transfer and initial stage of rotation, then, make a  $\gamma_T$ -jump before performing the final stage of rotation. In this scenario it may not be necessary to perform the second stage of rotation. The compression associated with crossing transition may be enough.

Below transition, as a particle is accelerated, its angular velocity increases. Above transition the situation is reversed; the particle behaves as if it had a negative mass. The bunch length is given by:

$$\Delta\phi = (-\eta\Omega_0/P_0R_0V\cos\phi_0)^{1/4},$$

where the focusing force should be replaced by an equivalent quantity that includes the space-charge contribution such that;

$$V\cos\phi_0 - (dE/ds)_{sc} < V\cos\phi_0, \quad \eta < 0,$$

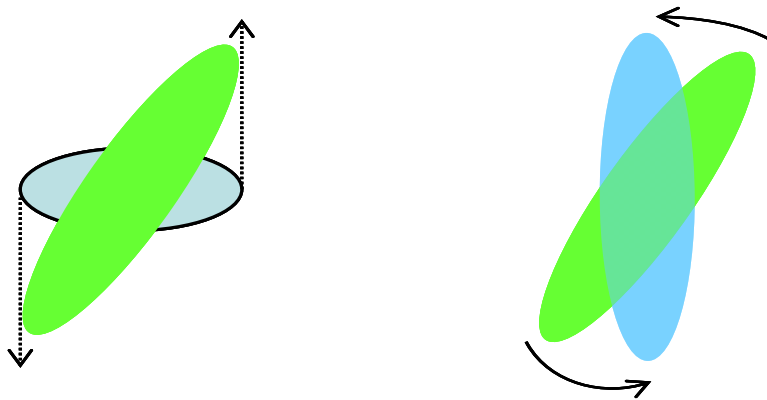
and,

$$V\cos\phi_0 + (dE/ds)_{sc} > V\cos\phi_0, \quad \eta > 0.$$

The positive sign of  $dE/ds$  when  $\eta > 0$  represents the attractive force due to the negative mass effect. The net effect is the bunch length is compressed as transition is crossed from below. At transition the frequency spread of the synchrotron oscillation is small. Once the transition is crossed the situation exists where the oscillations can be excited; this is the negative mass instability. The size/growth of the oscillations will depend on the beam intensity and the time spent in the regime with little damping. While the negative mass instability may provide self-bunching, it could also be accompanied by uncontrolled momentum spread. Two approaches can be taken to limit the transition losses/emittance blowup:

- Enlarging the area of the bunch before crossing transition to reduce the space-charge force.
- Minimizing the time spent at transition, i.e. vary  $\gamma_T$  in such a way that crossing speed is high; this is the  $\gamma_T$ -jump.

It is also possible to achieve very short bunches by performing the phase rotation in a ring operating very close to transition. From the equations governing longitudinal motion we know that when  $\eta = 1/\gamma_T^2 - 1/\gamma^2 = 0$  the bunch is frozen in phase while the momentum can continue to spread in the presence of an applied RF voltage. Conservation of longitudinal emittance implies the change of shape shown in Figure 3 (left). If the beam energy is dropped below the transition energy, the bunch will rotate to an upright orientation as in Figure 3 (right). Like the previous rotation scheme, this approach may also be sensitive to non-linear effects. Additionally, as the bunch is compressed the transition energy changes with the associated change in space charge; therefore, the motion may no longer satisfy the  $\eta$  condition required by the method. Additionally, the momentum spread may become unacceptably large. Performing the rotation with a small slip factor may mean that a significant amount of time could be needed.



**Figure 3: Bunch motion in phase space at transition (left) and below (right).**

The existing 8 GeV Fermilab Accumulator and Debuncher rings in the Antiproton Source are high-quality storage rings having the right energy and roughly the right circumferences for our purposes. Furthermore, their apertures are large. They are, however, in a shallow tunnel, which probably obviates using them in their current location. Nonetheless, they might serve the purposes described here if they are relocated to a deeper tunnel.

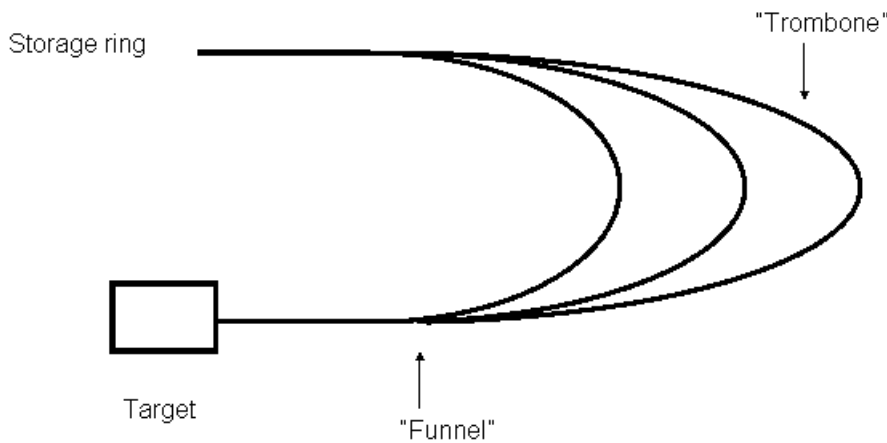
### 4.3 External Combiner

As discussed in section 4.1.1, the space charge effects in the rings can be mitigated by opting for a multi-bunch scenario rather than a single-bunch scenario. However, to satisfy the parameter specifications of a muon collider, it is desirable to have a very intense single bunch hit the target, regardless of whether a single-bunch or multi-bunch approach was used in the rings. This poses a problem in the multi-bunch scenario discussed in section 4.1.1. One way to satisfy the muon collider parameter specifications while maintaining tolerable space charge forces in the rings is to use a combiner. The combiner

is a set of transfer lines and kickers downstream of the rings that can allow more than one bunch to arrive simultaneously at the pion production target. The first major subsystem, the “trombone,” sends bunches on paths of different lengths. The second subsystem, the “funnel,” directs the multiple paths (distributed on a circle) to coincide at the pion production target. Figures 17 and 18 illustrate the concept <sup>41</sup>.

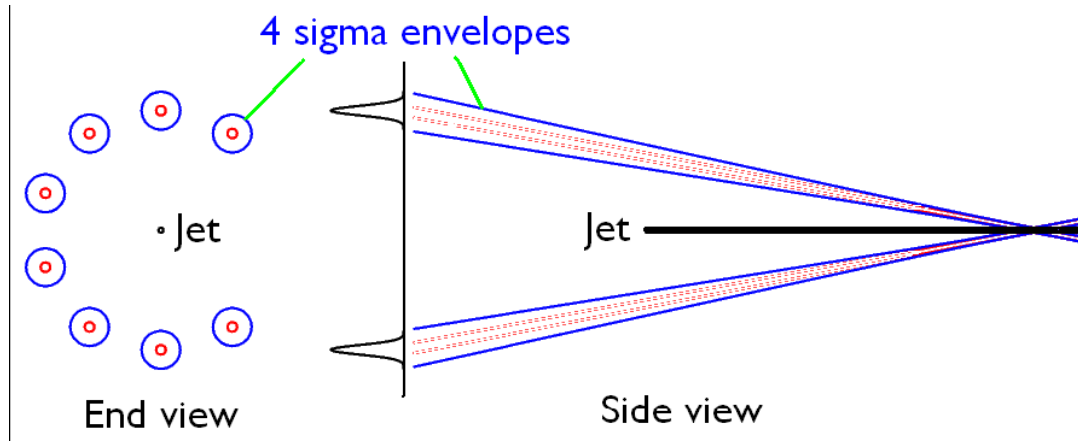
### 4.3.1 Trombone

Multiple extraction lines; 1<sup>st</sup> extracted bunch travels further that the last bunch extracted allowing bunches to be merged at the target.



**Figure 17: Schematic of trombone and funnel concept. This allows the merging of bunches at the target. This makes it possible to move from a single very intense bunch scenario to a multi-bunch scenario, thus easing the difficulties of handling the space change issues associated with a neutrino factory or muon collider.**

### 4.3.2 Funnel



**Figure 18: More detailed view of the funnel components**

## 5 Proton Driver Development Plan Based on IC-2.2 Linac

Considerable attention within the Project X design team has recently been focused on a variant of IC-2 called IC-2.2. That variant is based on a 3 GeV, CW SRF linac with a beam current of about 0.5 mA. Given the enthusiasm generated by that idea, it is important to have an idea how to develop that version of Project X into a proton driver for neutrino factories and muon colliders. The scenario described below for the development of a multi-megawatt proton driver from that initial configuration is appealing for a number of reasons. First of all, the plan allows an early start on activities leading directly to a proton driver for a neutrino factory and ultimately for a muon collider. The scenario is phased in stages and satisfies two primary requirements on a phased approach, namely that each stage must do good physics and that each stage must build upon and be a logical extension of the previous stage. Furthermore, it promises to be less expensive than other conceivable alternatives that might achieve the same goals.

### 5.1 The first-stage proton driver

The development scenario starts by adding a proton accumulation ring to the complex. The Project X Phase I CW linac would inject an average beam current of 0.5 mA at a kinetic energy of 3 GeV (or whatever beam current and energy result from Phase I), corresponding to 1.5 MW of beam power. The physics goal of this initial activity is to provide proton beam appropriately packaged to drive a neutrino factory based on a muon storage ring. The proton beam power and energy imply that the neutrino flux will be about a factor of three less than what is ultimately desired for a neutrino factory; however, the performance of the ultimate neutrino factory exceeds that of a facility based on a state-of-the-art conventional neutrino superbeam (a neutrino beam resulting from pion decays) by such a large factor that the proposed initial activity would still be capable of enabling interesting neutrino physics competitive with, and complementary to, that from a conventional neutrino superbeam. The beam from the neutrino factory could be directed toward detectors at DUSEL and/or NOvA. (Neutrino beams could be delivered to two locations simultaneously from a triangular muon ring.) Neutrino beams derived from the muon storage ring and from the Main Injector could be distinguished by timing. Some kind of magnetized detector would provide an important capability to determine the signs of the lepton charges produced in the interactions of muon and electron neutrinos and antineutrinos from muon decay.

In keeping with the notion of starting modestly, at least by neutrino factory standards, the initial neutrino factory could be based on a 4 GeV muon storage ring as described in Ankenbrandt et al.<sup>42</sup> In that case, the muon beam after cooling might be accelerated in two or more passes through the same linac that accelerates the H<sup>-</sup> ions. Alternatively, it could ultimately be a full-blown 20 or 25 GeV neutrino factory<sup>43</sup>. As a compromise to provide early physics results in a manner compatible with ultimate goals, the muon

storage ring could be configured to be compatible with muon beams of 20 or 25 GeV, but initially filled with 4 GeV beams.

General design concepts for the accumulation ring have been discussed above. Specific parameters for the systems that are needed between the linac and the pion production target, in order to transform the linac into a proton driver for a neutrino factory and/or a muon collider, can be developed as follows by working backwards from the beam parameters at the production target.

The goal of the first calculation is to determine an approximate upper limit on the tolerable transverse beam emittances. Smaller emittances would presumably be easier to handle, but it is necessary to make the transverse emittances as large as possible in order to reduce the space charge tune shift in the accumulating and bunching rings because their kinetic energy is only 3 GeV at this stage. If the space charge tune shift turns out to be smaller than necessary, then the emittances (and thus the apertures of the rings) can be reduced.

The current best design values for the major parameters of the pion production target and of the beam at the target result from the Mars simulations described above. The ideal rms beam size,  $\sigma$ , at the pion production target is about 2 mm. The ideal length of the mercury production target is about 33 cm. (The possible slight dependence of the optimal target length and diameter on the energy of the proton beam is ignored herein. Such effects can be taken into account in a subsequent more detailed design.) The effective length of the target in current designs is determined by the diameter of the mercury jet ( $\sim 1$  cm) and by the angle of the beam relative to the jet ( $\sim 30$  mrad). This gives the effective target length of about 33 cm.

If we assume that the beam optics will produce a waist (a minimum of the horizontal and vertical beta functions) at the target, then depth-of-focus considerations (similar to the hourglass factor in the formula for collider luminosity) argue that the value of the minimum beta should be comparable to the target length. A natural choice is to set them equal, choosing the minimum beta to match the target length of 33 cm. (It is probably feasible to produce such a small value of beta at the center of the mercury jet target, but this should be verified as part of a total engineering design of the target complex.) With this choice we can calculate the geometrical transverse emittances of the beam:

$$\varepsilon_{\text{rms}} = \pi \sigma^2 / \beta = \pi (2 \text{ mm})^2 / (0.33 \text{ m}) = 12 \pi \text{ mm-mrad}$$

Note that this is an rms, geometrical emittance. Normalized emittances containing 95% of a Gaussian beam (as usually quoted at Fermilab) can be found by multiplying the above value by  $6 \beta \gamma$ . For 3 GeV protons, the corresponding normalized 95% emittance is  $294 \pi$  mm-mrad. At a place in a ring where the beta function is 12 meters, a reasonable value for a small ring, the corresponding rms beam size is 12 mm, so the required apertures are not unreasonably large.

These values of the emittances and the minimum beta function imply the following rms angular spread of the beam:

$$\theta_{\text{rms}} = (\epsilon_{\text{rms}} / \pi \beta)^{1/2} = (12/0.33)^{1/2} = 6 \text{ mrad} = \epsilon_{\text{rms}} / \pi \sigma = 12/2$$

This value of the rms angle is 5 times smaller than the central angle at which the beam impinges on the mercury jet, which seems acceptable. The rms angular spread implies that the 5 sigma beam size at a location 5 meters upstream of the target will be of order 15 cm, which suggests that the final focusing quadrupoles can have reasonable apertures.

The next step is to consider whether it is feasible to accumulate and process the required beam intensities. Issues specifically related to injection of many turns into an accumulation ring have been discussed above. Here we turn to intensity-dependent effects. There are many effects that may impact performance, but space charge is often the limiting factor because there are a variety of ways to mitigate other effects. The space-charge tune shift has been discussed above. In this section the tune shift will be calculated for specific 3-GeV cases. The parameters used for the various cases considered in this section and the resulting tune shifts are shown in Table 5.



<b>Parameters at Production Target</b>				
sigmax	2	2	2 mm	rms H and V beam size
sigmat	3E-09	3E-09	3E-09 sec	rms bunch length
frep	210	210	15 Hz	rep rate of bunch arrivals at target
dtrgt	10	10	10 mm	diameter of mercury jet
thbmt	30	30	30 mr	angle of beam on target
Leff	0.333333	0.333333	0.333333 m	effective length of target
beta	0.333333	0.333333	0.333333 m	beta fcn at target center
epsrg	12	12	12 pi mm-mr	rms geometrical emittance
sigthta	6	6	6 mrad	rms proj angular spread at target
epsn95	293.5083	527.5301	527.5301 pi mm-mr	95% normalized emittance
<b>Proton Beam Kinematics</b>				
Ek	3	6	6 GeV	kinetic energy
Et	3.938272	6.938272	6.938272 GeV	total energy
mom	3.82487	6.874537	6.874537 GeV/c	momentum
beta	0.971205	0.990814	0.990814	
gamma	4.197367	7.394734	7.394734	
<b>Beam Intensity</b>				
lav	0.0005	0.000667	0.000667 Amps	average current
fduty	1	1	1	duty factor
lpk	0.0005	0.000667	0.000667 Amps	peak current
fcyc	70	70	15 Hz	cycle rate
Npdot	3.12E+15	4.16E+15	4.16E+15 /sec	protons/sec
Npcyc	4.46E+13	5.94E+13	2.77E+14	protons/cycle
nbun	3	3	3	bunches/cycle
Np	1.49E+13	1.98E+13	9.25E+13	protons/bunch
Pbeam	0.0015	0.004	0.004 GW	beam power
<b>Ring Parameters</b>				
B	1.8	3.235186	3.235186 T	dipole field
rho	7.087818	7.087818	7.087818 m	Bending radius
fp	0.5	0.5	0.5	Dipole packing factor
R	14.17564	14.17564	14.17564 m	Average radius
C	89.06815	89.06815	89.06815 m	Circumference
Nsts	2	2	2	
Lstraight	22.26704	22.26704	22.26704 m	
Bun	0.025312	0.025312	0.025312	Bunching factor
Delnusc	-0.08568	-0.02007	-0.09368	Laslett tune shift

**Table 5: Parameters for the three stages of the proton driver.**

The tune shift limits the intensity of individual proton bunches. For a given beam power and kinetic energy (1.5 MW and 3 GeV in the first stage), two factors determine the intensity of individual bunches: the repetition rate and the number of bunches per cycle.

An upper limit of 70 Hz on the repetition rate is determined by target disruption as measured in the MERIT experiment. That is, the length of the mercury jet that is disrupted by an intense beam and the speed of the jet flow imply that the disrupted part of the target moves out of the way in about 14 ms, corresponding to a 70-Hz rate. The tolerable rate might be increased by increasing the velocity of the jet, but for now the 70 Hz value will be used.

The International Scoping Study has specified that 3 bunches, closely spaced (by ~ tens of microseconds) in time, be delivered to the production target per cycle. The time spacing of the 3 bunches is limited on the high side by target disruption and on the low side by the desire to allow muon acceleration systems to recover from various effects such as beam loading resulting from the passage of previous bunches. (That document also specifies a 50 Hz cycle repetition rate, which would probably turn into 60 Hz on this side of the Atlantic, and it is assumed here that 70 Hz would also be acceptable.) Dividing a current of 0.5 mA into  $70 \times 3 = 210$  bunches per second yields individual bunch intensities of  $1.486 \times 10^{13}$  protons per bunch.

The tune shift formula includes a longitudinal bunching factor, defined as the ratio of average to peak beam current. The bunching factor will obviously be smallest after rotation. That prompts a word about some considerations that will affect the longitudinal distribution. As mentioned previously, the accumulation ring will probably operate slightly below transition. To form 3 equal bunches, barrier buckets will divide the circumference into 3 equal azimuthal sectors. In order to optimize the subsequent bunch-shortening rotation in longitudinal phase space, the beam will be chopped so that about half of the circumference is populated. In order to allow short bunches to be produced, the initial longitudinal emittance must be kept relatively small. So a debunching system after a long drift downstream of the linac will probably be necessary. In the IC-1 design, the linac beam downstream of the debuncher had a full momentum spread of 4 MeV/c. At a kinetic energy of 3 GeV, the corresponding fractional momentum spread is 0.001. The circumference of the accumulation ring is 89 meters for a dipole field of 1.8 Tesla and a dipole packing fraction of 50% (cf. Table 5). So the length of each bunch before rotation is  $89/6 = 15$  meters. In the ideal case where the longitudinal distributions before and after rotation are uniformly populated rectangles, the bunch could be rotated to a total length of ~ 3 meters, corresponding to an rms length slightly less than 1 meter or 3 ns, while increasing the fractional momentum spread by a factor of 5 to 0.5%. If more realistic distributions are used, the total momentum spread after rotation will probably be about a factor of 3 larger, i.e. about 1.5%. These numbers imply some safety margin providing flexibility to cope with various effects, provided that a lattice with considerable momentum acceptance is used. For example, one might opt to a larger initial momentum spread in order to cope with instabilities or to ease the requirements on the debunching system.

With all relevant factors now in hand, the space charge tune shift can be calculated, and the result is a very tolerable 0.086 (cf. Table 5).

It is conceivable that a single ring might suffice at this stage to provide both accumulation and rotation. However, as Garoby has pointed out<sup>44</sup>, it might be preferable not to have resonant rf cavities in the accumulation ring in order to avoid instabilities driven by their higher-order modes. Then a second ring, the rotator ring, would contain the resonant rf systems for bunch rotation, and the beam would occupy that ring for such a short time that instabilities would not have time to develop.

For a neutrino factory, there is another operating regime that is worth considering. Recall first that the muon proper lifetime is 2.2 microseconds. Then the dilated lifetime is 85 microseconds at 4 GeV, 522 microseconds at 25 GeV. So from that perspective it is reasonable to consider much larger cycle repetition rates of order a kHz or even higher for a neutrino factory. Furthermore, it is possible to avoid disruption of the mercury jet target completely by operating at bunch intensities below the disruption threshold. Alternately, it is possible that a solid target might be feasible at a beam power of 1.5 MW, particularly at high repetition rates.

A repetition rate considerably higher than 70 Hz, with correspondingly smaller proton bunch intensities, would alleviate any deleterious intensity-dependent effects in the proton storage ring(s). It would also make it easier to accelerate the muons in the same CW linac that accelerates the H<sup>-</sup> ions because the muon bunch intensities would be lower. It would take at least two passes through the high-energy part of the linac to raise the muon energy to 4 GeV. The optimum location in the linac at which to inject the cooled muon beam and various issues of joint use are topics for further consideration. The upper limit on the repetition rate might be determined by other subsystems such as injection/extraction kickers.

## 5.2 The second-stage proton driver

The next stage of development of the proton driver would coincide with the addition of an extension to the linac to raise its energy. Two important questions arise at this point: What energy and beam power are required, and should the extension be CW, like the Project X Phase I linac of IC-2, or pulsed?

Regarding the first question, there are at least two “customers” for an extended linac: the Main Injector and the proton driver for a NF/MC. In both cases, it will turn out that a kinetic energy around 6 GeV is high enough to suffice. For the proton driver, the beam current must be 0.667 mA to provide 4 MW of beam power.

For the Main Injector, it is known that the field quality is very good down to about 4 GeV. The choice of injection energy is then guided by at least two other considerations:

(1) What energy corresponds to the lowest frequency that its RF cavities can tune to? The present cavities may be able to reach a frequency corresponding to a kinetic energy as low as 6 GeV. However, the cavities will need to be upgraded anyway to handle higher beam power, and it would be natural at that point to modify the tuning range if necessary.

(2) How high an injection energy is required to make the space charge tune shift tolerable? The answer can best be derived by scaling from previous design work described in ICD-1 regarding injection at 8 GeV into the Recycler, at an intensity high enough to enable the Main Injector to deliver 2 MW of beam power. In that case the Laslett tune shift calculated from detailed simulations was  $\sim 0.04$  or  $0.05$ . For the same geometrical acceptance, the tune shift scales as  $1/\beta^2\gamma^3$ , providing a factor of 2.15 in going from 8 to 6 GeV. But the acceptance of the Main Injector is somewhat larger than that of the Recycler, so the tune shift would rise by about a factor of two to a still acceptable 0.09 at 6 GeV. Of course in this case, injection would be directly into the Main Injector, bypassing the permanent-magnet Recycler, whose energy is fixed at 8 GeV.

The second question is whether the linac extension should be CW or pulsed. There are three advantages of the pulsed option:

- a) It would operate at a considerably higher gradient (by about a factor of 1.5) than the CW version, providing potential cost savings;
- b) It seems simpler (but may not be; cf. App. 2) to inject into a ring from a pulsed linac;
- c) It may produce a smaller heat load on the cryogenic system, particularly for low average beam currents.

The CW version, on the other hand, provides a large number of significant advantages:

- a) It provides a natural upgrade of the initial Project X linac without the need for extensive modifications; conversely, there is no obvious well-established way to marry a pulsed linac to a CW one;
- b) A CW linac makes the repetition rate of the rings a continuous variable, implying considerable flexibility to adapt to varying needs, operational modes, and performance limitations;
- c) A CW linac has considerably more potential to upgrade the beam power;
- d) All deleterious effects dependent on bunch intensity are greatly alleviated;
- e) A CW linac is simpler and hence potentially more reliable than a pulsed one;
- f) Accelerator-driven subcritical reactor aficionados prefer CW linacs;
- g) Other potential users may need high duty cycle operation at more than 3 GeV;
- h) IOTs have advantages over klystrons.

On balance the advantages of the CW option appear to outweigh those of the pulsed version. One possible caveat is that it must be established that injection into an accumulator ring from a CW linac is feasible. If the staged approach advocated herein is adopted, then the feasibility will have been not only established by simulation but also demonstrated in the 3-GeV ring by the time a decision must be made whether to proceed with a CW extension of the linac.

So stage two of the development plan consists of raising the linac energy to 6 GeV via a CW extension, raising its current if necessary to 0.667 mA to provide 4 MW, and doubling the kinetic energy of the accumulator and rotator rings. Using the same rings as in the first stage means that they must be located, *ab initio*, far enough downstream to allow room for the linac extension as well as a possible debunching system. It also

implies that the magnets in the ring must now operate at 3.325 Tesla, i.e. they must be superconducting.

It is assumed that the second stage still supports operation of a neutrino factory, albeit now a full-blown one providing the parameters specified by the NF proponents. Although the proton beam intensity is 1.333 times higher than in stage 1, the rapid reduction of space charge tune shift with energy now provides a very modest tune shift of 0.02 at 70 Hz, using the same parameters as in the first stage (cf. Table 5). Operation at a much higher repetition rate is presumably also still viable.

The higher-energy linac now makes it possible to consider using it to accelerate the muons to 20 or 25 GeV by recirculating the beam through several passes for a high-energy neutrino factory. As discussed earlier, the muon storage ring might be the same physical object that was used for a 4-GeV ring, albeit operated with higher fields.

### **5.3 The third-stage proton driver**

The third stage would transform the stage-two system into a proton driver for a muon collider. Since higher luminosities result from lower repetition rates, at least until beam-beam limits are reached, it may be necessary to modify the system to operate at considerably lower repetition rates. Delivery of bunches to the pion production target at rates as low as 10 Hz have been suggested by muon collider proponents. Here a value of 15 Hz is used as a less extreme example.

Fortunately, raising the energy to 6 GeV has made it considerably more feasible. Now an external system between the rings and the target is needed to combine the three bunches at the target. (That system was not needed for the neutrino factory, as groups of three bunches were to be delivered to the target in that case.) The result is a tolerable tune shift of 0.094 (cf. the last column of Table 5).

It goes without saying that somewhere along the way, muon test facilities will be necessary, and providing them in a graceful way ought to be part of the plan. Also, it is possible that the ability to provide intense proton bunches and intense muon bunches might also be useful for other activities such as another muon  $g-2$  experiment and muon spin rotation facilities.

## **6 Conclusions and Recommendations**

The work reported here describes a number of important conceptual developments and supports a number of important conclusions. However, a caveat is necessary: much of the work is at a preliminary conceptual level. That is to say, much of it is not supported by full simulations, nor have detailed engineering designs been carried out. Therefore, some of the conclusions are tentative, with finalization awaiting the support that comes from those kinds of further efforts. That having been said, it is also true that a consensus has

developed that “things are jelling”, that the designers are on the right track with regard to both the proton driver and Project X itself.

The most promising design approach for a proton driver consists of a full-energy H linac, a pair of storage rings, and an external bunch combiner. The two storage rings are high-acceptance accumulator and buncher rings. The external bunch combiner allows several bunches to arrive at the same time at the pion production target. The linac could be either CW or pulsed, provided that it is capable of delivering at least 4 MW of beam power. If the initial Project X linac is significantly less than 6 GeV, it should be extended, using the same technology as the high-energy end of the initial linac, in order to provide the necessary kinetic energy and beam power.

If the need arises for more than 4 MW of beam power, either to enhance the operation of a neutrino factory or a muon collider or to allow simultaneous delivery of beam for other high power applications, then the linac current can be upgraded by adding or upgrading power supplies. Other spill demands could be satisfied with additional accumulator and buncher rings. A CW linac is more easily upgraded than a pulsed one, especially since the cryogenics will need little additional capability as the beam power is increased.

The need for more than 4 MW of beam power may arise for activities related to the development of linacs for ADS/ATW applications. Accelerators to drive subcritical reactors and to transmute the waste from conventional nuclear reactors may be an important future application of the SRF linac technology developed for Project X. Appendix 3 is a contribution to the workshop on Applications of High Intensity Proton Accelerators that describes how research using Project X could be used to advance the energy and environmental goals of the nation.

An important conclusion is that a kinetic energy of 6 GeV is high enough to support the 4-MW proton driver capabilities required for neutrino factory and muon collider applications. Regarding the important question of whether the linac should be CW or pulsed, our answer is a resounding “Yes!” That is, it should be hybrid: the RF power should be CW, but the beam current should be pulsed at a high frequency. That makes a “resonant foil bypass” possible in the accumulator ring. That, together with the other innovations described in this report, will facilitate the injection of a very large number of turns through a stripping foil into a ring from a linac whose average current is low. We have concluded that a hybrid linac is not only viable but also preferable for these purposes.

The development of the proton driver complex can be divided into three logical stages, with the first stage supporting a modest neutrino factory, the second stage supporting the ultimate neutrino factory, and the third stage supporting a high-luminosity muon collider. In the first stage, the proton storage rings would operate at the energy of the Project X linac; in subsequent stages, they would operate at 6 GeV.

A neutrino factory would be considerably less expensive if the muon emittances are small, allowing smaller acceptances to be used. Small emittances might even allow

acceleration of the muons in the same linac that accelerates  $H^-$ . Thus high priority should be given to the development of efficient muon cooling schemes such as helical cooling channels.

We recommend a quick start on the three-stage development plan. Much work remains to be done. Early priority should be given to activities that would provide added support for the conclusions drawn here.

In particular, *design and simulation work* should include:

- 1) Design and simulation of the accumulator and buncher rings, including a complete detailed design and simulation of the injection scheme.
- 2) Development of a siting concept: where to locate the necessary facilities on the Fermilab site. This should be addressed soon, as it ought to impact the decision about where to locate the Project X linac.
- 3) A full engineering design of the pion production target region, supported by conceptual designs and simulations of the beam transport systems, the so-called trombone and funnel.
- 4) Design and simulation related to the use of the linac to accelerate muons as well as  $H^-$ .
- 5) Continued studies of 6D muon cooling systems that would allow step 4) and
- 6) A study of neutrino factory solutions that would take advantage of more aggressive 6D cooling with muon acceleration in the P-X linac. This approach would make the neutrino factory into a project much more aligned with the ultimate goal of a muon collider.

Hardware R&D and experimental work should include:

- 1) Development of devices and systems that may facilitate multiturn injection, including rotating stripping foils and high-frequency dipoles.
- 2) Experimental work on stripping foil techniques, possibly including installation and testing of prototype devices in existing rings at Fermilab.
- 3) Engineering design of a high-efficiency 6-d cooling channel.
- 4) Testing of a prototype section of the above channel with beam.
- 5) Development of an  $H^-$  ion source that allows beam to be chopped at its exit.

## Bibliography and References

- 
- <sup>1</sup> Project-X ICD reference (<http://projectx.fnal.gov/>)
- <sup>2</sup> Draft Report from the ICD-2 Research Program Task Force
- <sup>3</sup> [http://www.fnal.gov/directorate/Longerange/Steering\\_Public/P5/Goldenbook-2008-02-03.pdf](http://www.fnal.gov/directorate/Longerange/Steering_Public/P5/Goldenbook-2008-02-03.pdf)
- <sup>4</sup> C. Albright, et al, “Physics at a Neutrino Factory”, Fermilab Report Fermilab-fn-692, ArXiv/hep-ex-0008064. Also see J. Tang and W. Winter, “Physics with near detectors at a neutrino factory”, PHYSICAL REVIEW D 80, 053001 (2009)
- <sup>5</sup> Physics at a Muon Collider, John Gunion, hep-ph/9802258
- <sup>6</sup> S. Geer, Phys Rev D **57**, 6989 (1998); 59, 039903(E) (1999)
- <sup>7</sup> A. De Rujula, M. B. Gavela, and P. Hernandez, Nucl. Phys. **B547**, 21 (1999)
- <sup>8</sup> A. Cervera *et al.*, Nucl. Phys. **B579**, 17 (2000); **B593**, 731(E)(2001)
- <sup>9</sup> S. Geer, O. Mena, and S. Pascoli, Phys. Rev. D **75**, 093001 (2007)
- <sup>10</sup> Adapted in part from the Project-X Golden Book, ver. 1, Feb 3, 2008 & Project-X ICD reference (<http://projectx.fnal.gov/>)
- <sup>11</sup> C. Ankenbrandt et al., “Low-energy neutrino factory design”, Phys.Rev.ST Accel.Beams 12:070101,20
- <sup>12</sup> See presentations by A. Bross and W. Winter at the International Design Study-Neutrino Factory Plenary Meeting at Mumbai, India, October, 2009, <https://www.ids-nf.org/wiki/TIFR-29-10-12/Agenda/Files?>
- <sup>13</sup> C. Ankenbrandt, et al, FERMILAB-PUB-09-0010APC (2009)
- <sup>14</sup> J.S. Berg, et al “International Scoping Study of a Future Neutrino Factory and Super Beam Facility”, RAL-TR-2007-23, <http://www.hep.ph.ic.ac.uk/iss/reports/ISS-AcceleratorWG-final.pdf>
- <sup>15</sup> H. Kirk, et al, “The MERIT High-Power Target Experiment at the CERN PS”, presented at IPAC08, Genoa, Italy, 23 - 27 Jun 2008, pp.WEPP169, FERMILAB-CONF-08-224-APC
- <sup>16</sup> N.V. Mokhov *et al.*, Fermilab-Conf-98/379; LANL Report LA-UR-98-5716(1998); <http://www-ap.fnal.gov/MARS>
- <sup>17</sup> N. Mokhov, et al “Pion production for Neutrino Factories and Muon Colliders”, Workshop on Applications of High Intensity Proton Accelerators, Fermilab October 19-21, 2009, [http://www.physics.princeton.edu/mumu/target/mokhov/mokhov\\_102009b.pdf](http://www.physics.princeton.edu/mumu/target/mokhov/mokhov_102009b.pdf)
- <sup>18</sup> M. Apollonio *et al.* “Forward production of charged pions with incident protons on nuclear targets at the CERN Proton Synchrotron”, Phys. Rev. **C 80**, 035208 (2009); A. Bolshakova, et al, “Tables of cross-sections of large-angle hadron production in proton{ and pion{ nucleus interactions I: beryllium nuclei and beam momenta of +8:9 GeV/c and -8:0 GeV/c”, Report CERN-HARP-CDP-2009-001



- 
- <sup>19</sup> N. Mokhov, et al “Pion production for Neutrino Factories and Muon Colliders”, Workshop on Applications of High Intensity Proton Accelerators, Fermilab October 19-21, 2009, [http://www.physics.princeton.edu/mumu/target/mokhov/mokhov\\_102009b.pdf](http://www.physics.princeton.edu/mumu/target/mokhov/mokhov_102009b.pdf)
- <sup>20</sup> D. Neuffer, “Recent Results on Muon Capture for a Neutrino Factory and Muon Collider”, FERMILAB-TM-2433-APC, <http://lss.fnal.gov/archive/test-tm/2000/fermilab-tm-2433-apc.shtml>
- <sup>21</sup> J. Gallardo, R. Palmer, A. Tollestrup, A. Sessler, A. Skrinsky et al., “ $\mu^+ \mu^-$  Collider: A Feasibility Study,” DPF/DPB Summer Study on New Directions for High Energy Physics, Snow-mass, Colorado, 25 Jun – 12 Jul 1996, BNL - 52503, Fermilab - Conf - 96 - 092, LBNL - 38946, <http://www.cap.bnl.gov/mumu/pubs/snowmass96.html>;
- C. Ankenbrandt et al. "Status of muon collider research and development and future plans," Phys. Rev. ST Accel. Beams 2 (1999) 081001, <http://prst-ab.aps.org/abstract/PRSTAB/v2/i8/e081001>
- <sup>22</sup> M. Zisman, Fermilab Muon Collider Physics Workshop, November 10, 2009, derived from estimates by R. Palmer and Y. Alexahin
- <sup>23</sup> Data from A. Jansson “Baseline scenario(s) for muon collider proton driver” Presentation at NUFAC08, cdsweb.cern.ch/record/1197739/files/Nufact08\_072.pdf, , updated from M. Zisman, *ibid.*
- <sup>24</sup> Y. Alexahin, “Helical FOFO Snake Update” LEMC09, <http://www.muonsinc.com>
- <sup>25</sup> Y. Derbenev and R.P.Johnson, Phys. Rev. Spec. Topics Accel. and Beams 8, 041002 (2005)
- <sup>26</sup> K. Yonehara, HCC, Muon Collider Design Workshop, Dec. 2009, <http://www.cap.bnl.gov/mumu/conf/collider-091201/talks/KYonehara1-091201.ppt>
- <sup>27</sup> T. J. Roberts, G4beamline, <http://www.muonsinc.com/>
- <sup>28</sup> M. Neubauer, RF Design for HCC, Muon Collider Design Workshop, Dec. 2009, <http://www.cap.bnl.gov/mumu/conf/collider-091201/talks/MNeubauer1-091201.pptx>
- <sup>29</sup> A. Zlobin et al., Magnet R&D for muon beam cooling at FNAL, MCDW, BNL, Dec. 2009. <http://www.cap.bnl.gov/mumu/conf/collider-091201/talks/AZlobin3-091201.ppt>
- <sup>30</sup> K. McDonald, et al, “The Merit High-Power Target Experiment at the CERN PS”, Proceedings of PAC09.
- <sup>31</sup> K.Gudima, M. Mokhov, and S. Striganov, Workshop on Applications of High Intensity Proton Accelerators (19-21 Oct 2009)
- <sup>32</sup> D. Neuffer, “Recent Results on Muon Capture for a Neutrino Factory and Muon Collider”, FERMILAB-TM-2433-APC, <http://lss.fnal.gov/archive/test-tm/2000/fermilab-tm-2433-apc.shtml>
- <sup>33</sup> R. Garoby, Workshop on Applications of High Intensity Proton Accelerators (19-21 Oct 2009 )
- <sup>34</sup> R. Garoby, E. Benedetto, M. Aiba, M. Meddahi, Linac-based proton driver for a neutrino factory, Proceedings of Workshop on Applications of High Intensity Proton Accelerators (19-21 Oct 2009 )
- <sup>35</sup> C. Ankenbrandt and R. Johnson, Proceedings of Hadron Beam 2008, WGE08
- <sup>36</sup> [http://www.fnal.gov/projects/muon\\_collider/prstab/prstab.pdf](http://www.fnal.gov/projects/muon_collider/prstab/prstab.pdf)

<sup>37</sup> J.E.Griffin, C. Ankenbrandt, J.A. MacLachlan, A. Moretti, IEEE TNS 30, p3502, 1983.

<sup>38</sup> Proposal to search for  $\mu^-N \rightarrow e^-N$  with a single event sensitivity below  $10^{-16}$

<sup>39</sup> R.Palmer, Workshop on Applications of High Intensity Proton Accelerators (19-21 Oct 2009 )

<sup>40</sup> C. Prior, Proton Drivers for a Neutrino Factory, Lecture from Neutrino Factory School, Abingdon, UK, June 2002

<sup>41</sup> B. Palmer, Proton Bunching Options, Workshop on Applications of High Intensity Proton Accelerators (19-21 Oct 2009 )

<sup>42</sup> C. Ankenbrandt et al., “Low-energy neutrino factory design”,Phys.Rev.ST Accel.Beams 12:070101,20

<sup>43</sup> J.S . Berg et al., “International Scoping Study of a Future Neutrino Factory and Super Beam Facility”, RAL-TR-2007-23, <http://www.hep.ph.ic.ac.uk/iss/reports/ISS-AcceleratorWG-final.pdf>

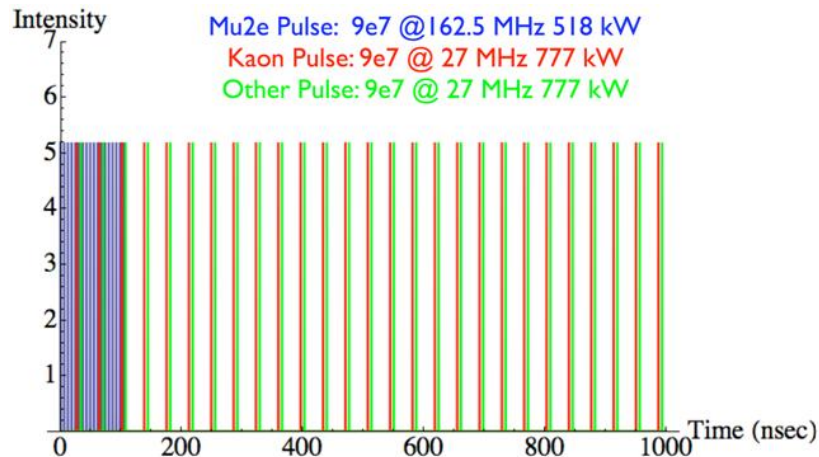
<sup>44</sup> R. Garoby, presentation at NUFACT09 and remarks at AHIPA workshop

## Appendix 1: Ion Sources

### Negative Ion Sources for Project X

The source should produce essentially a CW (continuous wave) beam (95% duty-factor) of  $H^-$  at 6 to 10 mA for use in the 2 to 3-GeV programs. Every 100 ms a 5 ms pulse with a lower beam current of  $\sim 2$  mA will be delivered to the 8-GeV programs. Most important is the beam current ramp-up and ramp-down times which should be less than 0.5 ms. Ion source reliability should be  $>95\%$  and the rms normalized beam emittance from the source should be  $\sim 0.2 \pi$  mm-mr, close to that of the SNS.

An additional important requirement for  $H^-$  sources for future FNAL accelerator systems is flexible beam chopping with nanosecond resolution. As an example, Figure 1-1 presents a possible beam structure to support a muon conversion experiment, rare kaon experiments, and a third unspecified program. Using an RF splitter running at five-fourths of the bunch frequency (406.25 MHz), every other pulse is available to the muon experiment, so a burst of 32 162.5-MHz bunches (100 ns) of  $9 \times 10^7$  ppb can be provided. The other RF buckets are equally split between two other experiments. To match the 20-30 MHz desired bunch spacing, further chopping can be done and provide beam at 27.1 MHz. In this example the CW linac provides 518 kW of 2 GeV  $H^-$  ions for the muon conversion experiment and 777 kW to the two additional locations simultaneously. In this example the  $H^-$  ion source delivers about 5 mA DC. The average current is then reduced to 1 mA by chopping.



**Figure 1-1: 1  $\mu$ s period of the proton linac, with blue pulses for the muon conversion experiment, red for rare kaon decay experiments, and green for other experiments.**

In order to provide this beam structure, the chopping system should provide the possibility to kick out any separate bunch. However, in this case 80% of the beam current is to be chopped out. If the chopper is placed after RFQ accelerator when the protons

have energy of 2.5 MeV, the power of the part of the beam that is chopped out will be more than 5 kW, which requires a special optics system that directs the chopped bunches to the beam dump. If the chopper is placed before the RFQ, when the proton energy is ~50 keV, the power of the beam chopped out is 500 W. This will require a special target installed before the RFQ that sustains 500 W and doesn't allow the chopped out beam penetration into the RFQ.

An adequate possible solution is to use an ion source that allows fast beam current modulation. This modulation may provide chopping of the main portion of the beam that should be removed, where other systems only clean out smaller remaining portions.

### **Background**

Several CW and long-pulse (e.g. 3600s) mA-class H<sup>-</sup> ion sources are currently operating in existing cyclotrons and tandem facilities for BNCT (Boron Neutron Capture Therapy), neutron and resonant gamma ray production, etc. Larger multi aperture H<sup>-</sup> sources have been and are continuing to be developed for fusion applications such as plasma heating and diagnostics. Both of these types of sources should be distinguished from a large group of short-pulse, higher-current H<sup>-</sup> sources (typically < 1ms at 5-120 Hz) used to inject high energy accelerator facilities such as BNL-AGS, DESY, KEK, RAL-ISIS, FNAL, ANL-IPNS, J-PARC, SNS and LANL-LANSCE. When specifically considering long-pulse and CW H<sup>-</sup> sources we should also distinguish between 'experimental' sources and truly 'operational' sources which have been proven at existing facilities and have supporting metrics data available. Here is a list of possibilities to consider:

#### **Filament-Driven Multicusp Ion Source**

The first source that comes to mind is the TRIUMF multicusp, Cs-free, filament-driven source which is now being commercialized by D-Pace, Inc. [1]. They offer a CW 15 mA source which is employed in the TRIUMF TR30 facility. Morgan Dehnel, President of D-Pace says, "Our TRIUMF licensed ion source has an established track record at the TR30 MDS Nordion Radioisotope production Facility operated by TRIUMF staff at the TRIUMF site. These TR30's have been operating for over 20 years with this performance. Nordion's normal operating mode is now to use a buncher after the DC source beam (to pulse the beam to match the cyclotron RF) so they can run at 10 mA H<sup>-</sup> DC beam output upstream of the buncher. In this mode for over 10 years they run 3-4 weeks 24/7 and then a filament change." Morgan also states that this source is also used at IBA, Sumitomo, KAERI and Thales. The TRIUMF 500 MV cyclotron also uses an earlier version of this source which injects about 1 mA of H<sup>-</sup>. Jyvaskyla University also employs a similar early version of this source.

The advantage of this approach is that it is a very well established system with lots of operational metrics available. In order to make these beam currents the source uses a large 11-13 mm outlet aperture which likely contributes to its comparatively large emittance:

16.4mA 0.32  $\pi$  mm mrad 1-rms normalized.  
10.6mA 0.28  $\pi$  mm mrad 1-rms normalized.  
8.11mA 0.26  $\pi$  mm mrad 1-rms normalized.  
5.27mA 0.23  $\pi$  mm mrad 1-rms normalized.

Ref: [http://www.d-pace.com/products\\_hion.html](http://www.d-pace.com/products_hion.html)

These values exceed those of the Project-X specification: 0.2  $\pi$  mm-mr rms normalized. Of lesser concern is a filament change every 3-4 weeks, which, depending on the actual length of change, can cut into the >95% ion source availability requirement leaving little time for additional issues. Morgan does, however, comment that the time to change a filament and re-condition to full quiescent beam, can be achieved in less than 4 hours. We can assume a 3-week run period that is less than 1% downtime associated with filament changes, which could be conveniently scheduled on maintenance days. Another unknown is the ability of the source to quickly switch between two levels of beam current. One could imagine adding a pulsing circuit to the 120 V 50 A arc supply (operated at >20 A for 10 mA of H<sup>-</sup>). We have asked this question to the TRIUMF engineers. We also note the power efficiency of this source at 15 mA is approximately 15 mA/5kW or 3 mA/kW. Note that the d=13 mm outlet aperture has 3.4 times the area of the SNS sources.

### Penning Ion Source

Another approach is to consider the BINP-BNCT Penning type H<sup>-</sup> CW source [2] which has been in operation producing ~10 mA for ~3 years (~40h/week) at BINP with run intervals of ~200 hours (for 15 mA) with source conditioning taking <1 hours (0.5% down time). Some source parameters are: Emission aperture: d=3 mm (or 1.5 x 6 mm<sup>2</sup> slit); discharge parameters: 80 V x 4.5 A = 360 W for 10 mA H<sup>-</sup> beam (efficiency 30 mA/kW); rms normalized emittance for 15 mA is <0.2  $\pi$  mm-mr. This source does employ Cs ~1mg/hr. It may be possible to rapidly lower and raise the discharge current from the programmable arc power supply to achieve the required current shift from say 10 to 2 mA within the 500  $\mu$ s. Most likely the BINP group could be approached about testing this at their facility.

Ref: Belchenko et al, NISB 2008, AIP Conf. Proceedings 1097, 2009, p. 214.

### RF-Multicusp Source

Alternatively, one should also consider LBNL-type internal [3] or SNS-type external antenna sources [7]. These sources utilize comparatively very small quantities of Cs (little to no Cs consumption) and can produce H<sup>-</sup> currents with efficiencies of ~1mA/kW of applied RF power into <0.2  $\pi$  mm mrad RMS normalized phase space. We believe that stepping the RF generator through two power levels to produce alternating 2 mA or 10 mA currents would not be problematic given the H<sup>-</sup> beam rise and fall times observed

by turning the RF on and off which are typically  $\sim 50 \mu\text{s}$  which is much less than the  $500 \mu\text{s}$  requirement. More problematic would be the effect of increased average RF-power on the internal antenna or, for the case of an external antenna source, the ceramic plasma chamber. The Project-X near CW requirement of 6-10 mA indicates that the source design should be capable of withstanding approximately 6-10 kW of RF/plasma heating at this source efficiency.

Currently the baseline LBNL source with ORNL internal antennas has operated in pulsed mode routinely injecting 30-40 mA (up to nearly 1 ms, 60 Hz) of  $\text{H}^-$  into the SNS accelerator with 2-3 kW of average RF heating power (typically 30-50 kW pulsed at nearly 6% duty factor) and performs well. Continuous operational periods of 3-weeks and source availability  $>99\%$  have been achieved. It is unclear how much more average power the internal antenna porcelain enamel coating can handle but early work at LBNL suggests that an upper limit was encountered for 1 s pulses at RF powers of 7 kW. See attached reference. Currently infrequent antenna failures occur in the 2-3 kW average power range. Also uncertain is how other internal components of the source such as the Cs-collar and filter field structure would be affected by the increased average RF power, however the TRIUMF source has eliminated these components internally. Since the metallic plasma chamber is directly water cooled it is likely to be able withstand these RF/plasma power densities without problems.

SNS-type, external antenna sources, in their present form, are also limited due to cooling requirements of the Aluminum Nitride (AlN) ceramic plasma chamber ( $D = 6.8 \text{ cm}$ ). The source has been designed to operate with a maximum of 7 kW of average RF power with a factor of safety of 2 with respect to thermal stress using FEA simulation but has only been tested with up to  $\sim 4 \text{ kW}$  of average RF power over extended periods of time. A recent two-month run of a prototype version of the source on the SNS accelerator has produced a net availability of 97% with the reliability issues identified and their solutions currently being implemented. Scaling to Project-X requirements, uncertainties involving internal source components like the filter and Cs-collar also apply in this case. Presently, CERN is also developing a similar source, based on a similar AlN-plasma chamber, for linac-4 and it has been designed to handle 6-kW heat loads. Potentially this type of source offers the highest reliability and lowest maintenance of the available options, e.g. the DESY external antenna  $\text{H}^-$  source has operated for over 2 years without maintenance (pulsed with a low duty-factor). At least one of two developments will be required in order to allow this source to be suitable for Project-X: (i) increasing the power handling capability of the ceramic plasma chamber and/or (ii) improving the source power efficiency above  $\sim 1 \text{ mA/kW}$ .

(i) To increase the power handling capability of the ceramic AlN plasma chamber, one could increase the radial size of the SNS plasma chamber by  $\sim 7 \text{ mm}$  which, based on calculation, should accommodate the required 10 kW average power load while preserving the factor of 2 safety margin. Conservatively, if one increased the radial dimension by 20 mm, the thermal stress on the larger plasma chamber with a 10 kW heat load would be comparable to the smaller chamber with a 4 kW heat load. This analysis assumes the total RF power requirement is approximately constant – further analysis is

warranted if this approach is elected. Alternatively, one could consider the use of a slotted metallic Faraday shield between the plasma and ceramic chamber. This approach has been taken at IPP in Garching for the ITER fusion ion source. The IPP source (plasma chamber diameter = 24 cm) routinely operates with ~100 kW CW RF heat loads by employing a thin, slotted, water-cooled, metallic Faraday shield. Recent plasma density measurements of the driver region of the source suggest that comparable densities at comparable RF power levels to the LBNL source can be achieved. For example, plasma densities of  $n_e=2.5 \times 10^{12} \text{ cm}^{-3}$  at  $P(\text{RF})=40 \text{ kW}$  (pulsed),  $P=12 \text{ mTorr}$ ,  $D=10 \text{ cm}$  have been measured in the LBNL internal antenna source versus  $n_e=2.5 \times 10^{12} \text{ cm}^{-3}$ ,  $P(\text{RF})=34 \text{ kW}$ ,  $P=3 \text{ mTorr}$ ,  $\phi=24 \text{ cm}$  measured in the IPP source. This suggests that an external antenna source with Faraday shield can easily withstand a 10 kW heat load as well as operate with comparable source efficiencies ~1mA/kW.

(ii) As mentioned above, another approach is to increase the power efficiency of SNS-type external antenna sources. Efforts are currently ongoing to improve this at SNS, CERN, and Muons, Inc. See, for example, the attached references such as [7]. Efforts to improve source magnetic confinement, RF coupling using ferrite-backed inductive antennas as well as helicon antennas, and improvements to the extraction system are currently being pursued. For example, Muons, Inc. and SNS are exploring the use of a transverse saddle-type antenna coupled with a longitudinal magnetic field. Simply increasing the RF efficiency to 2 mA/kW could eliminate the need for resizing or Faraday shielding of the existing plasma chamber [8].

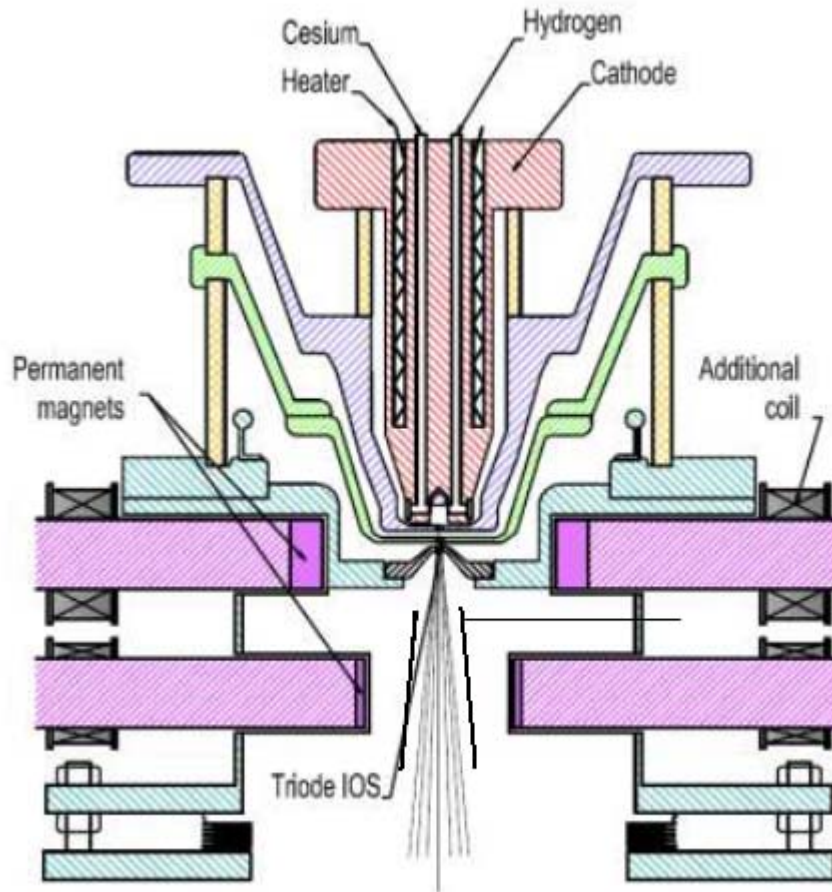
### **Outlook:**

In this note we have shown that the Project-X ion source requirements are in line with several existing ion source technologies (RF multicusp, filament multicusp, and Penning) but will clearly require some development work to demonstrate that all requirements can simultaneously be met by a single source. We believe the highest, long-term potential for reliability and minimal maintenance would be an RF-external antenna type source but that path will likely require more development work than, for example, modifying the extraction system of a commercially purchased TRIUMF-type source to reduce emittance or retrofitting the BINP Penning source. Here we have restricted our considerations to operationally well-established, proven sources or their variants which are most likely able to meet the requirements of Project-X. We have not considered the large number of 'experimental ion sources' where claims of high performance can be found in the literature but long-term operational and reliability data do not exist. We also admit a bias towards sources that we know well.

### **Ion Source with Flexible Ion Beam Chopping**

With a slit emission aperture it is possible to have a fast and flexible deflection of the ion beam necessary for ion beam distribution. For beam deflection along the narrow beam size it is possible, as in the case of the SPS (surface plasma source) ion source, to use a relatively short deflector plate or a short traveling wave deflector with relatively low

voltage for very fast (nanosecond) beam deflecting as in fast oscilloscopes. Such an SPS ion source is shown in Figure 1-2 [2] with deflector plates after extraction.



**FIG. 1-2: SPS with Penning discharge and with slit emission aperture. Modulation of the extraction voltage (in the first extraction gap) and modulation of the deflection voltage can be used together for flexible chopping of the ion beam. This SPS is capable of sustained operation with CW  $H^-$  beam intensity up to 20 mA.**

In the existing SNS RF [3] ion source,  $H^-$  beam chopping by a sectioned electrostatic Einzel lens with a length of  $\sim 2$  cm and internal diameter of  $\sim 1.5$  cm has a rise time  $t \sim 50$  ns. Beam chopping after the RFQ by a traveling wave deflector has  $t \sim 10$  ns rise time. With a smaller beam size ( $\sim 3-5$  mm) it is possible to have a chopping rise time  $t \sim 3-5$  ns with a relatively low deflection voltage, which is important for reliable long term operation. A deflecting plate design and deflecting electronics from fast electron oscilloscopes can be used for this application.  $H^-$  beam focusing by a special electrostatic lens has been demonstrated successfully. With this focusing the rise and fall time of the chopped beam will be independent of space charge neutralization. With the slit emission

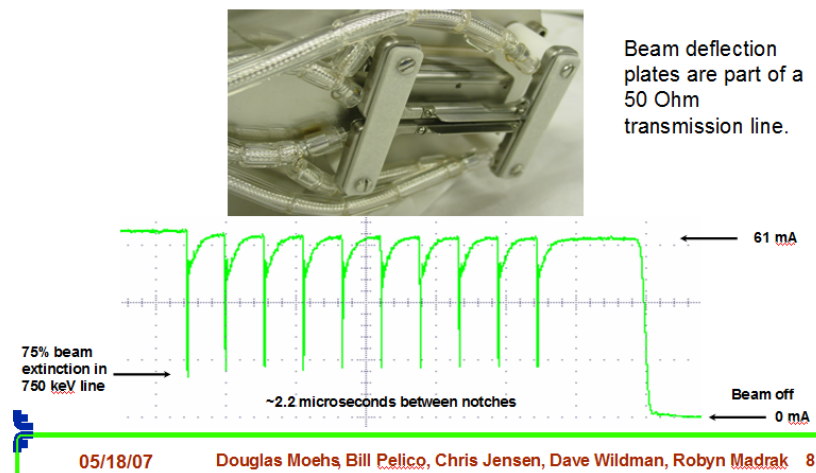


aperture it is possible to extract the ion beam without aberrations in the direction along the slit and have minimal aberrations in the transverse direction.

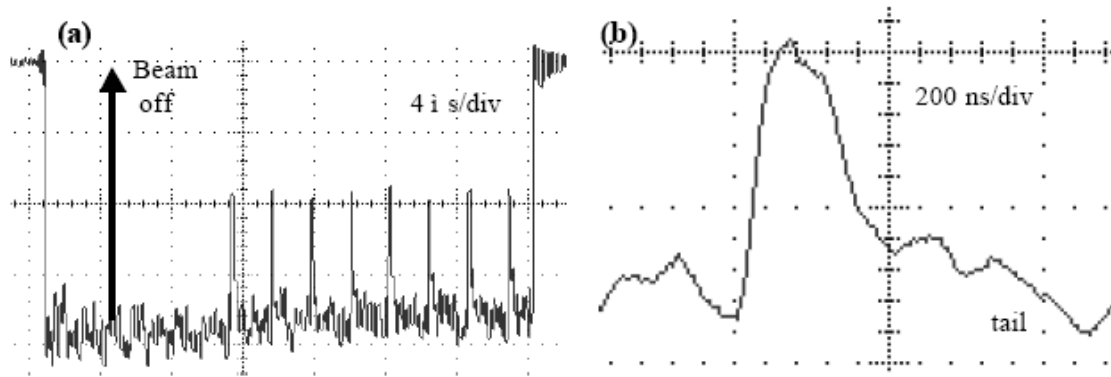
This type of  $H^-$  beam chopping was tested with the Fermilab magnetron SPS by D. Moehs [4]. An ambitious neutrino research program at Fermilab has created a demand for 8 GeV proton intensities greater than the existing Proton Source (Linac and Booster) can provide. Increases in proton intensity are presently limited by component activation associated with proton losses at high energies. Several projects have been initiated to address this problem including realignment, new magnets, and beam collimation in the Booster. As part of this effort, beam notching at low energies is being developed specifically to reduce the losses associated with beam injection and extraction from one accelerator to the next. Efforts to cleanly notch low energy beams has persisted, despite complications associated with space charge, inspired by the low beam rigidity and the relatively low cost associated with fast kilovolt pulsed-power supplies. At the SNS, a pulsed electric dipole deflector in the 65 keV LEBT (low energy beam transport) is being used to create chopped beams [3]. At KEK, a modulated surface-plasma converter source has modulated beams with 70 ns rise and fall times [5]. Furthermore, a traveling wave chopper utilizing special timing for a 35 keV beam was presented at the LINAC 2002 conference. The split extractor technique presented below [4] is complementary to these efforts. It is hoped that low energy space charge problems will be avoided by notching in the extraction region where the beam is expected to be space charge limited, due to the strong electric field of the extractor. The high gas pressure inherent to this region should also facilitate fast space charge recovery.

The design of the Fermilab magnetron SPS with deflectors for fast beam chopping (top) and pulsed of chopped  $H^-$  beam are shown in Fig. 1-3 below.

- Effort are on going to achieve this at the ion source but....
  - The environment is tough on the pulsed power supply
  - Space charge effects appear to limit the beam recovery time

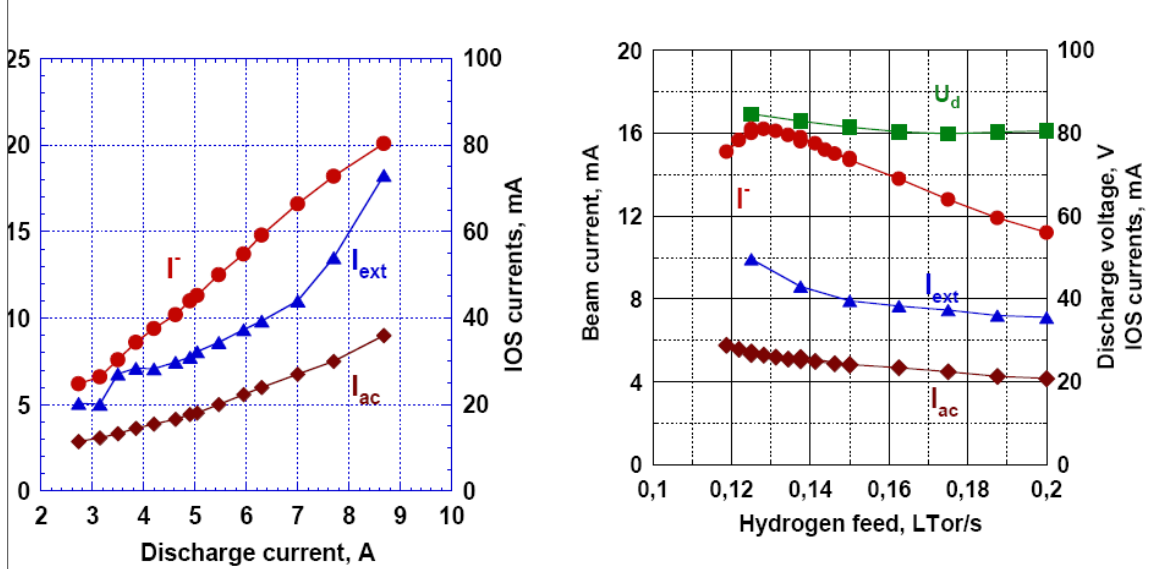


**Fig. 1-3: Design of Fermilab magnetron SPS with deflectors for fast beam chopping (top) and pulsed of chopped  $H^-$  beam (bottom) from [4].**



**Fig. 1-4: A 20 mA beam of H minus with 50% notching observed at 750 keV using a Pearson current transformer. (b) The rise and fall times of one notch is magnified in figure b.**

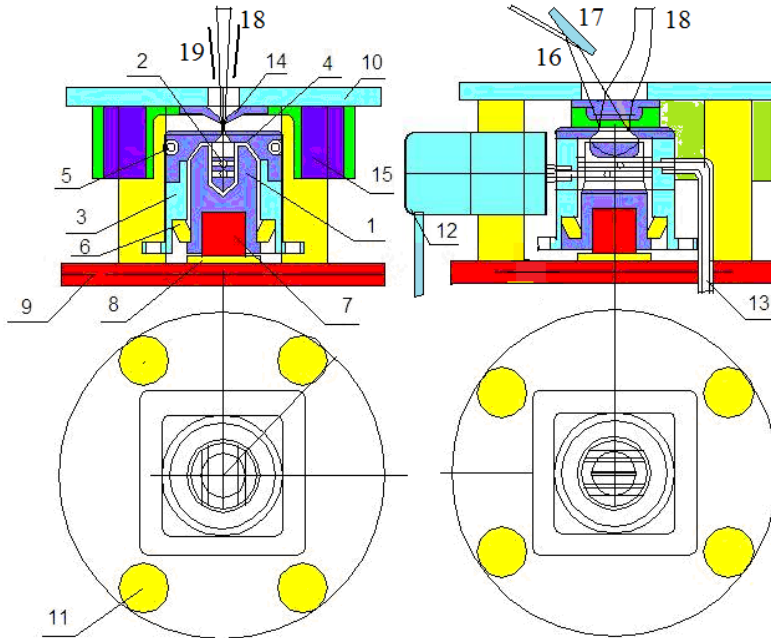
Dependences of H<sup>-</sup> beam current on discharge current and gas feeding for Penning SPS [2] are shown in Fig. 1-5.



**Fig. 1-5: Dependences of H<sup>-</sup> beam current on discharge current and gas for Penning SPS [2].**

For addressing these problems a design and adaptation of the advanced Penning discharge SPS with reliable generation of high brightness H<sup>-</sup> beam in noiseless discharge is proposed by Muons, Inc. The Schematic of the proposed modification is shown in Figure 1-6. The design and operation of the proposed source is clear from the caption.

In discharges with high plasma density and increased distance between cathodes surfaces and the emission aperture, the  $H^-$  ion from the cathode cannot reach the emission slit without destruction. In this case only the surface plasma generation of  $H^-$  on the plasma electrode (anode surface plasma generation of negative ions-SPG) around the emission aperture is important. In previous experiments it has been demonstrated that this anode SPG is efficient. Previous plasma generation experiments used a discharge with a cold molybdenum cathode in hydrogen with cesium admixture. The admixture of cesium decreases the work function of the cathode and anode and increases the secondary emission of electrons and negative ions.



**Figure 1-6: Schematic of Advanced version of the type Penning discharge SPS for pulsed and CW chopped  $H^-$  beam production.**

1- cathode ( Mo); 2-anode ( W); 3-source body ( St.St.); 4- cooled plasma plate ( Mo); 5- anode cooling; 6- cathode insulator; 7-cathode cooler ( Cu); 8- thermal conductive insulator ( AlN); 9-cooled flange ( Cu); 10- base plate ( St.St.); 11-high voltage insulator ( ceramic AlN); 12- gas delivery system( pulsed valve); 13- cesium delivery system; 14- extractor ( Mo); 15- magnet ( SmCo) + coils; 16- laser beam; 17-mirror; 18-negative ion beam; 19-deflector.

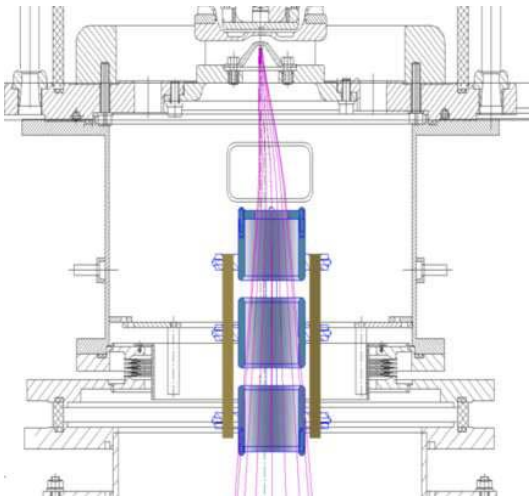
For stability of the optimal cesium film, it is important to maintain the optimal temperature of the surface. Sources with large size should therefore be better for plasma generation. The cesium concentration and conditions for SPG should be optimized on the plasma plate surface around the emission aperture.

Slit extraction is very adequate for  $H^-$  production by the anode SPG. A low ion temperature is preserved very well during slit extraction. An increased emittance along the slit, observed in discussed work [6], is connected with aberrations of a small fraction of the beam from the ends of slit and can be decreased by collimation.

A three or four electrode extraction system can be used for production of ideal beam optics with a very low current of coextracted electrons. It is important to suppress the secondary emission of  $H^-$  and cesium ions from the extractor.

All these comments are applicable to the DC ion sources described in publication [2]. The combination of proposed improvements can deliver high quality  $H^-$  beam with a pulsed intensity up to  $\sim 100$  mA and with average current up to 20 mA.

With a slit emission aperture and with narrow beam it is possible to have a fast and flexible deflection of the ion beam necessary for ion beam distribution. For beam deflection along the narrow beam size it is possible to use a relative short deflector plate (19 in Fig. 1-6) or a short traveling wave deflector with relative low voltage for very fast (nanosecond) beam deflecting as in the fast oscilloscopes. Using of electrostatic Einzel lens for cw  $H^-$  beam focusing tested in [2] is shown in Fig. 1-7.



**Fig. 1-7: Using an electrostatic Einzel lens for CW  $H^-$  beam focusing.**

The proposed version of the  $H^-$  ion source meets the requirements of the currently planned experiments for the Project X era.

#### References:

[1] [http://www.d-pace.com/products\\_hion.html](http://www.d-pace.com/products_hion.html)

[2] Ref: Belchenko et al, NISB 2008, AIP Conf. Proceedings 1097, 2009, p. 214.

[3] J. Staples, et al “The SNS Four-phase LEBT Chopper”, Proceedings of the 1999 Particle Accelerator Conference, New York, 1999

[4] Douglas P. Moehs, "Sub Microsecond Notching of a Negative Hydrogen Beam at Low Energy Utilizing a Magnetron Ion Source with a Split Extractor", FERMILAB-CONF-04-383-AD.

[5] K. Shinto, A. Takagi, K. Ikegami, and Y. Mori, *Rev. Sci. Instrum.* **71**, 696 (2000).

[6] J. D. Sherman et al, Proc. EPAC 2002, 3 June, Paris, France, p.284.

[7] Welton R. F, et al., H(-) ion source developments at the SNS. *Rev Sci Instrum.* 2008 Feb; 79(2 Pt 2); Welton R. F, et al., 2008, AIP Conf. Proceedings 1097, 2009; PAC2009, Vancouver, 2009.

[8] V.Dudnikov, et al., PAC 2009, Vancouver, 2009.

## Appendix 2: CW SRF linac for MC, NF, rare decays, AHIPA 09

### **CW SRF H<sup>-</sup> linac as a proton driver for muon colliders and neutrino factories<sup>1</sup>**

MILORAD POPOVIC<sup>1†</sup>, CHARLES M. ANKENBRANDT<sup>2</sup>, ROLLAND P. JOHNSON<sup>2</sup>

<sup>1</sup>*Fermilab, P.O. Box 500, Batavia, IL, 60510, USA*

<sup>2</sup>*Muons, Inc., 552 N. Batavia Ave., Batavia, IL, 60510, USA*

We describe a Project-X proton driver based on a CW Superconducting RF Linac with final energy as high as 8 GeV. This machine would have the potential to produce multi-MW H<sup>-</sup> beams to drive the Fermilab neutrino programs, rare kaon and muon decay experiments, muon cooling R&D programs, neutrino factories, and muon colliders. Keys to a CW machine to suit these uses include ways to generate the desired bunch trains and ways to accumulate many protons in an intermediate storage ring before they are bunched and directed to a target. Enhanced carbon foil techniques can allow accumulation of intense proton beams from a CW linac, which we propose to be extended from 3 GeV to as much as 8 GeV for the most efficient muon production for colliders and neutrino factories and to replace the Booster for improved Main Injector operation.

### **Introduction**

One of the possible realizations of Project X [1] at Fermilab is a CW Superconducting RF Linac accelerating H<sup>-</sup> beam to 3 GeV. The initial mission of the linac would be to provide intense kaon and muon beams for rare-process experiments. Such experiments typically require high macroscopic duty factors; a variety of bunch lengths, intensities, and patterns are required. Elaborate chopping and beam switching techniques are envisioned to satisfy these requirements simultaneously for multiple experiments. The chopping would occur at high enough frequencies that the high-Q RF cavities would effectively average over the beam microstructure. The beam needed for these experiments, with average beam current as high as 1 mA and kinetic energy as high as 3 GeV, would, with additional acceleration, also provide the basis for the higher-energy, multi-MW beams that are needed for neutrino factories and muon colliders. Additional acceleration beyond the energy of the CW linac of Project X would also allow beam to be delivered to the Main Injector.

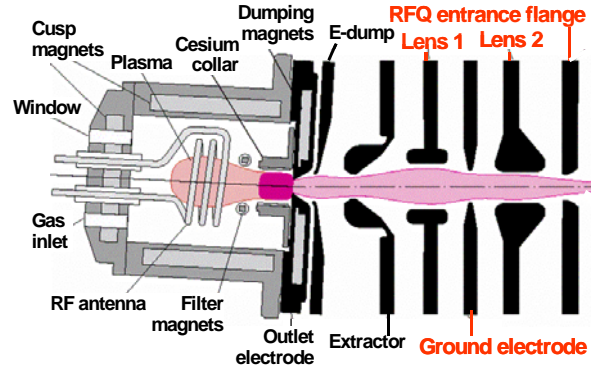
### **Low Energy Linac Front End**

The proposed front end for Project X based on a CW SRF Linac assumes a 10 mA H<sup>-</sup> source with a warm CW RFQ. The RFQ would operate at 325 MHz or 162.5 MHz to allow the chopper to reject individual bunches. To reduce residual radio-activation, it has been suggested that the output energy of the RFQ be less than 2.5 MeV. Since the required beam peak current is low, the input energy of the RFQ can be 30 keV. Except for the continuous beam requirement, these parameters are not very demanding for the RFQ. The input energy and relatively low peak current also make chopping of input beam less difficult. SNS operation has demonstrated that an ion source extraction system combined with electrostatic focusing and a very short LEBT can preserve the beam emittance even with a peak current of 40 mA. The present SNS LEBT is 12 cm long and allows chopping 200 ns of 40 mA beam at 1 MHz rep rate.

---

\* Supported in part by Fermilab Research Alliance, LLC under Contract No. DE-AC02-07CH11359

† popovic@fnal.gov



**Figure 1: SNS Ion Source with LEBT.**

Lowering the peak current to 10 mA reduces space charge effects, removes the need for beam neutralization, and allows a longer electrostatic focusing system with less demanding peak voltages for chopping. It is assumed that the very different beam structure requirements for different experiments can be satisfied by chopping at low energy and splitting with transversely-kicking RF to multiple experiments downstream of the linac.

### **CW Linac from 3 GeV to as high as 8 GeV**

It is likely that the 3 GeV Linac, after the Front End and the MEBT, will be based on 325 MHz spoke cavities up to ~200 MeV, continued with 650 MHz  $\beta=0.6$  five-cell bell-shaped cavities up to ~500 MeV, followed with 650 MHz  $\beta=0.9$  cavities up to about 2 GeV and 1.3 GHz ILC-like cavities up to 3 GeV. It is natural to assume that the linac extension beyond 3 GeV also will be based on the same 1.3 GHz technology extended to a final energy as high as 8 GeV.

### **Beam Delivery and Beam Accumulation**

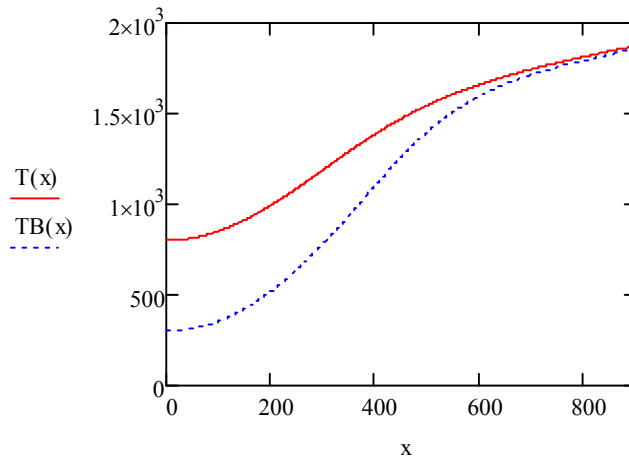
A currently open issue is whether the linac extension should be pulsed or CW. There are various pros and cons. A CW extension would seem reasonable because no modifications to the original 3 GeV CW linac would be needed, no additional R&D would be needed for the  $\beta=1$  cavities, and there is not yet a convincing method to make the transition from CW to pulsed mode that conserves the potential beam power enabled by the CW portion.

Muon colliders and neutrino factories need a relatively small number (as few as 10 for a collider, as many as 300 for a factory) per second of intense, short ( $\ll 3$  ns rms) proton bunches arriving at a pion production target. One or more “post-processing” rings will undoubtedly be necessary to provide the required bunch structures. The crux of this paper is to consider whether and how a CW linac can be used to fill an accumulator ring for these purposes. There are two issues, the long accumulation time and, if a classical stripping foil is used, foil heating.

Another likely use of a higher energy linac would be to fill the Main Injector for its neutrino program to allow the aging Booster synchrotron to be retired. This case is considered first as an example of how to cope with long accumulation time and foil heating. We assume protons are accumulated in the Recycler from a 1 mA CW linac at 8 GeV using existing foil stripping technology. For 4 mm linac beam radius,  $600 \mu\text{g}/\text{cm}^2$  carbon foil, and assuming that on average every proton comes back onto the foil every 5th turn, we calculate that the temperature of the foil can be kept below 1800 degrees, and  $1.5 \times 10^{14}$  protons can be accumulated in the Recycler in less than 100 ms. Techniques discussed below can reduce the time to inject the whole beam in 2200 turns into the Recycler in 24 ms. Figure 2 shows the foil heating and cooling for the case of injecting in the Recycler. Similar considerations would apply for the case of injecting directly into the Main Injector from a CW linac of less than 8 GeV.

Injection into an accumulation ring for the neutrino factory and/or muon collider case is considerably more challenging, requiring more turns to be injected, because each of these applications requires about 4 MW of beam power and because the accumulation ring must be considerably smaller in circumference than

the Recycler (or Main Injector) to alleviate space-charge effects in the subsequent bunch-shortening ring. However, there are also a few factors that will make it easier. The aperture of the ring will be considerably larger than the Recycler in order to accommodate the very large beam sizes that are required in any case to make space charge effects tolerable. The added phase space for the circulating beam, combined with the small emittance of the injected beam, makes it less likely that circulating protons will strike the foil. And the smaller CW injected beam current ( $\sim 1$  mA or less) means that the foil does not overheat where the incoming beam strikes it. Basically, stretching out the injection process in the CW case allows the foil to radiate considerable power during the injection process, whereas in the pulsed case the injection time is too short to allow much radiative cooling during the incoming beam pulse.



**Figure 2: Foil Temperature vs. number of injected turns for initial foil temperatures of 300K (TB-blue dotted) and 800K (T-red solid).**

The above factors are probably not sufficient to make a convincing case that foil-stripping injection is feasible from a high-power CW linac. Fortunately, four new concepts have been developed that make it plausible that injecting as many as  $10^5$  turns into a ring using a stripping foil will be feasible. Of course detailed simulations of the whole process will be necessary to help decide the issue.

*Resonant Foil Bypass:* The first new idea was presented at the Workshop on Applications of High Intensity Proton Accelerators at Fermilab [2], and dubbed “resonant foil bypass” by the organizers of the parallel session. Basically, the idea is to modulate the incoming beam at a relatively high frequency (so high that the high-Q SRF cavities average over the gaps) using the chopper, and to move the closed orbit synchronously at the foil so that it is closest to the foil only when the incoming beam is “on”. In other words, the idea is to run the CW linac with pulsed beam, albeit beam that is pulsed at a high frequency. If the average current during the pulses is 10 mA and the macroscopic average current is 1 mA, then the probability of a circulating proton hitting the foil might be reduced by about an order of magnitude by this means.

*Longitudinally Segmented Stripping Foils:* The second idea is to take advantage of the facts that the optimum stripping foil thickness for a multi-GeV beam is about  $600 \mu\text{g}/\text{cm}^2$  and that  $200 \mu\text{g}/\text{cm}^2$  thick stripping foils have proven to be quite durable. Thus the stripping foil can be segmented longitudinally into (say) 3 foils, so that there are six surfaces to dissipate the heat by radiation instead of two. The use of at least two foils has been advocated in the past to mitigate the effects of any “pinholes” in the foils.

*Rotating Stripping Foils:* The third idea is to rotate a circular foil rapidly, with an annulus having a radial extent of about 1 cm exposed in one corner of the aperture. That will spread out the energy deposition over an effective area of several square cm. Mechanical concepts for mounting and supporting such a rotating foil are being developed.

*In-ring Debuncher Cavities that also Decelerate:* The fourth idea is a so-called in-ring debuncher. Conventionally, debunching cavities are located after a long drift downstream of the linac to reduce the momentum spread of the linac beam before it enters the ring. It is possible that such cavities could instead be located in the ring itself, almost a full turn downstream of the injection region. If they are operated in such a way as to decelerate the incoming beam as well as to rotate it in longitudinal phase space, and if the



foil is located in a dispersive region, then this can also reduce the probability that circulating beam strikes the foil on subsequent turns. If the RF frequency of the debunching cavities is not an integer multiple of the revolution frequency, then they will not form buckets that would capture the beam. Simulation will show whether the quasi-random kicks on subsequent turns are tolerable. With luck, they may serve to stabilize the beam rather than to disturb it.

## Conclusions

We have presented a concept of a multi-MW CW linac with energy up to 8 GeV that could serve as a natural upgrade to the 3 GeV CW SRF Project X linac that is now under active consideration. We have shown that injection of  $1.5 \times 10^{14}$  particles in 100 ms in the Recycler can be done using conventional foil stripping, keeping the foil temperature below 1800K. Four new concepts were presented that may allow injection of very large numbers of turns from a CW linac into a proton accumulation ring. The accumulated proton beam can then be transferred to another ring where the intense bunches are shortened by a rotation in longitudinal phase space and targeted to create intense pion and muon beams for a neutrino factory and/or a muon collider.

## References

- [1] Fermilab Project X <http://projectx.fnal.gov/>
- [2] C. Ankenbrandt, "Accumulation and Bunch Rotation Schemes", Workshop on Applications of High Intensity Proton Accelerators, October 19-21, 2009, Fermi National Accelerator Laboratory, Batavia, IL, USA.  
<http://conferences.fnal.gov/App-Proton-Accelerator/index.html>

## Appendix 3: P-X, SRF, and Very Large Power Stations, AHIPA 09

**Project-X, SRF, and Very Large Power Stations<sup>2</sup>**CHARLES M. ANKENBRANDT<sup>1</sup>, ROLLAND P. JOHNSON<sup>1†</sup>, MILORAD POPOVIC<sup>2</sup><sup>1</sup>*Muons, Inc., 552 N. Batavia Ave., Batavia, IL, 60510, USA*<sup>2</sup>*Fermilab, P.O. Box 500., Batavia, IL, 60510, USA*

We seek to develop accelerator-driven subcritical (ADS) nuclear power stations operating at more than 5 to 10 GW in an inherently safe region below criticality, generating no greenhouse gases, producing minimal nuclear waste and no byproducts that are useful to rogue nations or terrorists, incinerating waste from conventional nuclear reactors, and efficiently using abundant thorium fuel that does not need enrichment. First, the feasibility of the accelerator technology must be demonstrated. Fermilab is developing concepts for Project X, which would use a superconducting RF (SRF) linear proton accelerator to provide beams for particle physics at the intensity and energy frontiers. We propose to extend this linac design to serve as a prototype for a practical accelerator that can drive several ADS reactors at once and also provide beams for reactor development.

**Overview**

A commercial GW-scale ADS power plant requires a proton accelerator with a beam power of at least 10 MW. Recent accelerator developments promise to make even more powerful accelerators feasible. There is a new opportunity to explore the relevant concepts in concert with another project, thereby achieving considerable synergies and cost savings. Namely, Fermilab is developing concepts for Project X, which would use a superconducting RF (SRF) linear accelerator that could deliver megawatts of beam power to provide beams for particle physics at the intensity and energy frontiers. One concept calls for an 8-GeV pulsed SRF linac; another concept is for a CW linac with a lower initial energy of about 2 GeV. One of the steps in proceeding through the Department of Energy's critical decision process from CD0 to CD1 is to look at alternative designs. In that spirit, Muons, Inc., Fermi National Accelerator Laboratory (Fermilab, High Energy Physics), Thomas Jefferson National Accelerator Facility (JLab, Nuclear Physics), and the Oak Ridge National Laboratory Spallation Neutron Source (SNS Basic Energy Sciences) have proposed to examine alternative designs for Project X that would be consistent with the needs of ADS and ATW. For example, the use of continuous-wave (CW) RF may enable production of tens of MW of beam power, considerably more than what is required for the intermediate-term HEP program at Fermilab, at a modest incremental cost relative to the baseline Project-X. The linac could serve as a prototype of a device that could drive several ADS reactors at one location, an approach which will become increasingly attractive with the development of the national power grid using low-loss transmission lines based on new superconductors.

The first major milestone of the project discussed here is to produce an enhanced or alternative design for Project X that includes ADS and ATW development needs. The planning, component development, construction, and operation of the machine will be the first step toward a practical accelerator for ADS and ATW based on SRF. Once constructed, the proton beam would allow tests and development of reactor components. Combining the goals of the High Energy, Nuclear Physics, and Basic Energy Sciences communities of DOE with the national energy and environment goals will lead to many

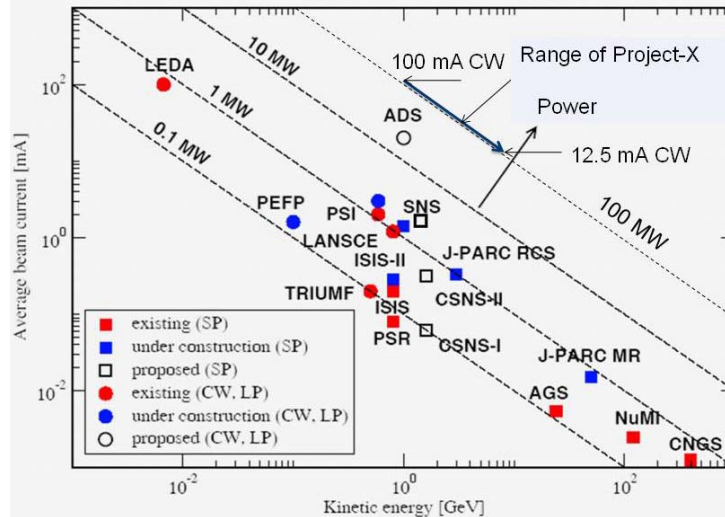
---

\* Supported in part by Fermilab subcontract to Muons, Inc. under DOE DE-AC02-07CH11359

† rol@muonsinc.com

desirable outcomes including lower costs, better technology, faster implementation, and the synergies that come from talented people working together to solve critical national and global problems.

Figure 1 shows the present and planned accelerator parameters that can be compared to the potential of a CW Project-X.

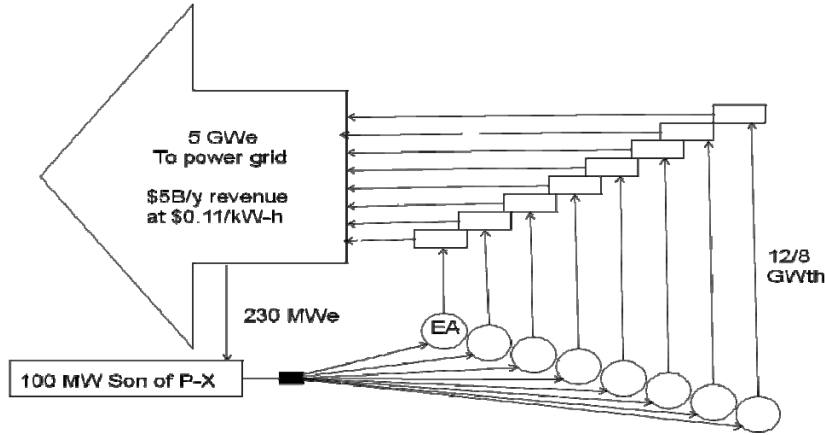


**Figure 1: Present and planned high-intensity proton accelerators. Original data compiled by J. Wei and S. Henderson. The present power record is held by the ORNL SNS. The range of parameters that could be explored by Project-X is indicated on the 100 MW line.**

In ADS schemes, spallation neutrons are produced by a 10 MW beam of protons on a high Z target. The fast neutrons (1-10 MeV) interact with Thorium 232 (fertile nucleus) to convert it to Protactinium which in turn decays into Uranium 233 (Fissile nucleus). (Similarly for U 238, one can make Plutonium 239 which is fissile). Additional neutrons induce fission to produce power.

It has been shown that neutron production from a proton beam increases almost linearly with proton energy for energies above 1 GeV. Consequently, it is reasonable to consider beam power as the relevant variable such that a lower beam current accelerated to higher energy can provide the needed beam power. Or, as we propose here, a large current at higher energy can supply several ADS reactors in parallel.

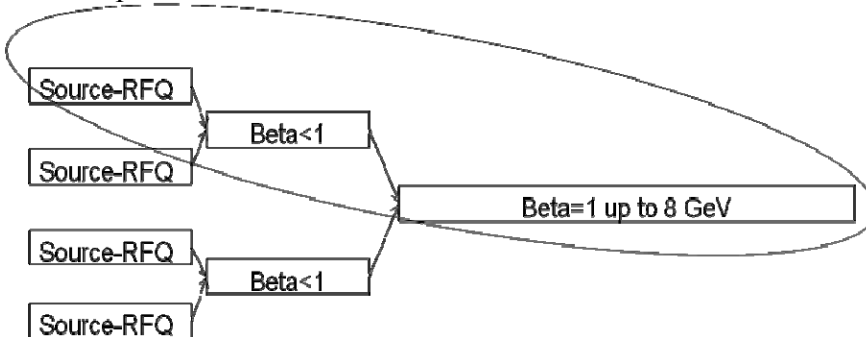
Essential advantages of using a higher-power higher-energy machine to drive several ADS/ATW reactors simultaneously compared to one accelerator for each reactor include better efficiency and lower cost. By creating most of the beam power with higher-gradient, more-efficient SRF cavities operating where the proton velocity is close to the speed of light ( $\beta=1$ ), capital and operating costs are reduced.



**Figure 2: Schematic of a large power station that is driven by an SRF proton linac that could be developed using the proposed Fermilab Project-X. The 100 MW beam is distributed to 8 thorium-burning Energy Amplifiers (EA) as described by Carminati et al.[1]. Each EA feeds a steam turbine to provide power to the national grid.**

### Higher-Energy SRF Linacs

Since the 1993 study by Carminati et al., SRF has become much more mature, with many examples of successful projects. The 6 GeV CW Continuous Electron Beam Accelerator Facility (CEBAF) at JLab has demonstrated reliable SRF operation, while advances in cavity construction and processing have shown higher gradients and quality factors that will lead to lower construction and operating costs for future machines. The 1 GeV SRF linac at the Spallation Neutron Source at ORNL, while operating in 60 Hz pulsed mode, is being used to explore many of the issues relevant to reliable operation and control of losses at high beam power that will be essential for ADS applications. A proton beam power near the MW-level has already been achieved at SNS, thereby demonstrating the feasibility of one of the key technologies required for ADS. Free Electron Lasers and synchrotron light sources that are based on CW SRF are likewise becoming commonplace.



**Figure 3: Schematic of an accelerator with sufficient redundancy to serve as a practical driver for the power station described in figure 2. The components enclosed by the ellipse represent Project-X.**

The special additional requirement for ADS uses, and an important reason to have an ADS prototype, is that the accelerator must be extremely reliable. This requirement is motivated not so much by the desire for steady power output but by the concern that

reactor components might be damaged by sudden changes in power level. We will propose to demonstrate this reliability by invoking a combination of component selection and redundancy, where figure 3 indicates how Project-X can be used for this development. For example, instead of fanning out power from one klystron to many RF cavities, we can use individual power sources for each cavity. A power source failure in this latter case can be compensated by adjusting the synchronous phase of the other cavities in the linac.

The original motivation for this proposal to operate Project X as a CW machine was to make sure that there would be sufficient beam power to satisfy future needs that might not yet be known. Considering that the present Booster synchrotron will have operated more than 40 years by the time it is replaced by Project-X, it seems also likely that there will be intensity needs that are yet to be imagined in the lifetime of Project-X. Developing beams for ADS reactors may be the first example of an otherwise unanticipated reason to have a generous supply of several-GeV protons at Fermilab. Potential high energy physics beneficiaries of such a proton source include a muon colliders and neutrino factories.

#### Reference

[1] F. Carminati, R. Klapisch, J.P.Revol, Ch. Roche, J.A.Rubio, and C. Rubbia, , CERN-AT-93-47. [http://ppd.fnal.gov/experiments/e907/raja/energy\\_amplifier/convert\\_at-93-047.pdf](http://ppd.fnal.gov/experiments/e907/raja/energy_amplifier/convert_at-93-047.pdf)